

Tunnel LED



Product information

Bring great light from Tungsram into your tunnels with the TLBt and TMBt, Tungsram's new single and double module tunnel lighting fixtures. The TLBt & TMBt are available in a range of optical combinations for flexibility across a wide range of applications such as low and high speed tunnels, underpasses and industrial areas. Maintenance in a tunnel environment can cause a headache not only for the operators but for the users as well. Tungsram' engineers therefore put major focus on developing a highly durable and reliable product with a long lifetime, providing an easy and rapid tool-less maintenance solution to speed up installation and reduce disruptive maintenance, as well as its costs. Safety is another important aspect regarding tunnels in which lighting has a key role. Our tunnel lighting solution can increase light quality and therefore safety through better visibility for drivers, who can react more rapidly to emergencies and other situations in tunnels, where every second matters.

Application areas

- Underpasses
- Industrial areas
- Floodlight

Driver features

- Drivers available from 75 up to 165 Watts with dynamim, AMPdim and DALI control.
- Minimum dimming level: 15W for TLBt and 30W for TMBt

Optics

Available photometric distributions:

- Extra narrow Asymmetric – medium (A)
- Narrow Asymmetric – medium (B, B5, AQ)
- Asymmetric – short (C)
- Asymmetric forward – very short (D)
- Asymmetric – medium (E, E5)
- Extra narrow Symmetric – medium (SA)
- Narrow Symmetric – medium (SB, SB5)
- Symmetric – short (SC)
- Symmetric forward – very short (SD)
- Symmetric – medium (SE, SE5, Y)

Rated colour rendering index: >70

Rated correlated colour temperatures*: 3000k, 4000K, 5000K

S/P rating for: 3000K - 1.22, 4000K - 1.5, 5000K - 1.71

ULOR: 0

Rated initial chromaticity co-ordinate values:

- 3000K: CIE(x=0.4338, y=0.403) 5SDCM
- 4000K: CIE(x= 0.3818, y= 0.3797) 5SDCM
- 5000K: CIE(x= 0.34, y= 0.35) 5SDCM

Installation and maintenance

Mounting options:

- Two types of fixing bracket are available: short arm for ceiling mounting, and long arm for wall mounting. Additional mounting solutions are available on request.
- Weight: 9 Kg
- Recommended mounting height: 4-8 m
- The LED light engine and driver are replaceable without the need of tools, enabling a quick and easy maintenance solution
- Recommended maintenance factor for lighting design: 0.8
- Ambient temperature from -40°C to +50°C
- Storage temperature up to 85°C

Structures and materials

Housing material: die-cast aluminium

Optical material: aluminised plastic or aluminium

Optical cover: tempered glass

Colour: RAL9005

All materials used in this product are WEEE and ROHS compatible.

Performance

Rated luminous flux: from 4250 to 22840 lm

Rated luminaire efficacy: up to 143 lm/W

Photometric code: 730/559, 740/559, 750/559

Rated median useful life and the associated rated LM factor:

L80B50 > 181.000 hours

Rated useful life and the associated rated LM factor: L90B10 >

78.000 hours (TMBt)

L90B10 > 79.000 hours (TLBt)

Rated abrupt failure value: value < 10% at 100.000 hours*

Lumen maintenance code: 9

Rated ambient temperature (tq) related to performance for a

luminaire: 25°C

*Definitions and tolerances according to IEC62722-2-1:2014

Electrical

Input voltage and frequency: 220-240V, 50-60Hz

Class I, Class II

Surge immunity: minimum 10kV in Class I, minimum 6kV in Class II

Rated input power: 33W to 176W

Other options available

Precabing, Mounted connectors with DALI loop-in loop out, Extra surge protection device (10kV/5kA)

Standards and regulation

CE, ENEC, Directive 2014/30EU, 2014/35/EU, 2009/125/EC, 1194/2012/EU, 2011/65/EU, EN 60598-1 & EN 60598-2-5, EN 62471, EN 55015, EN 61000 (61000-3-2 and 61000-3-3), EN 62493, EN 61547, IEC 62031.

Typical photometrical features

1 module

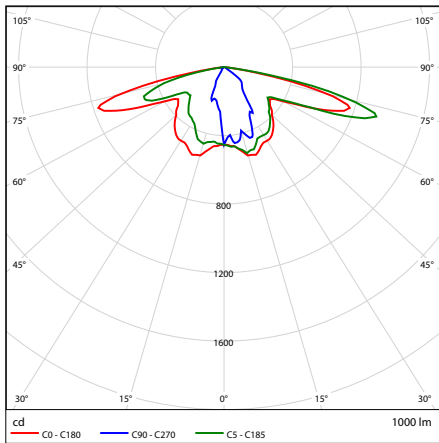

A

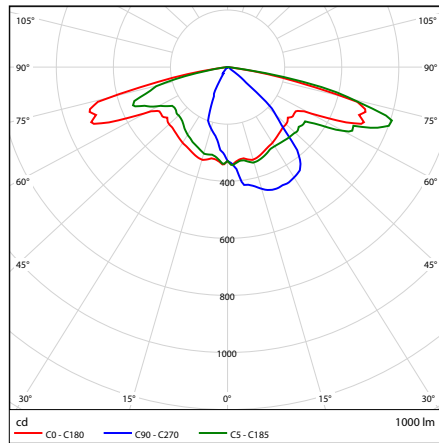

B

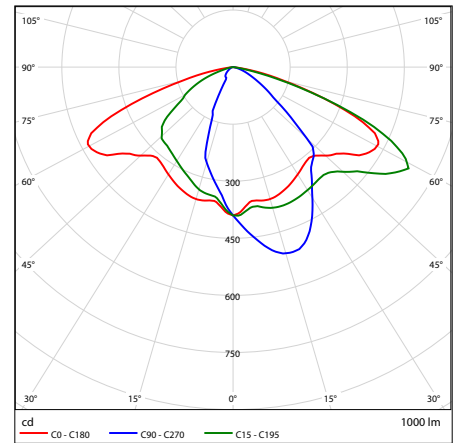

B5

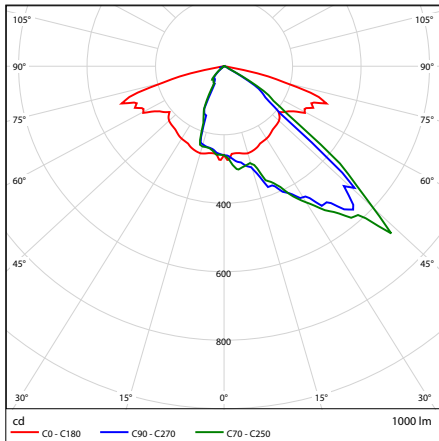

C

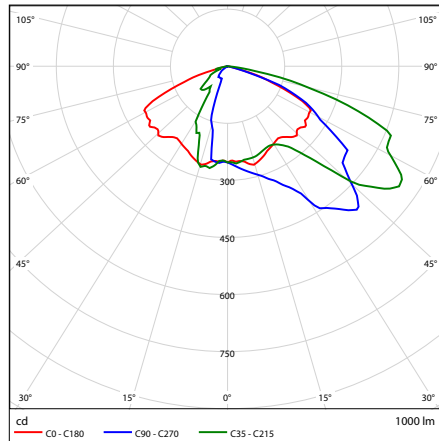

D

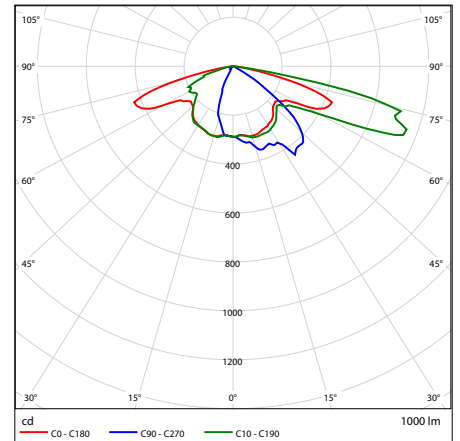

E

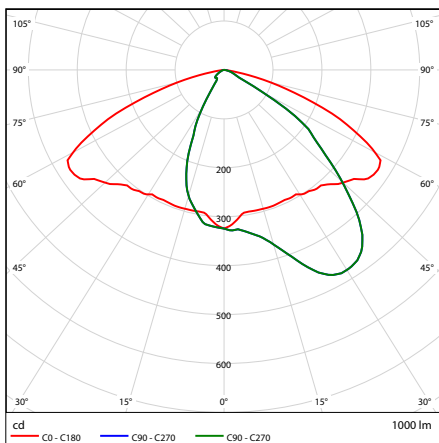

E5

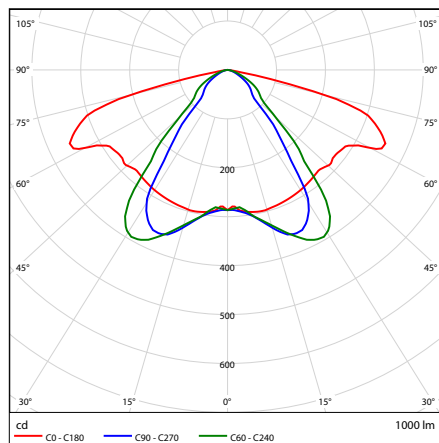

Y5

2 modules

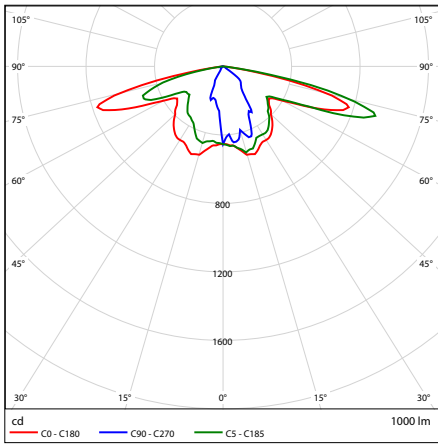

AA

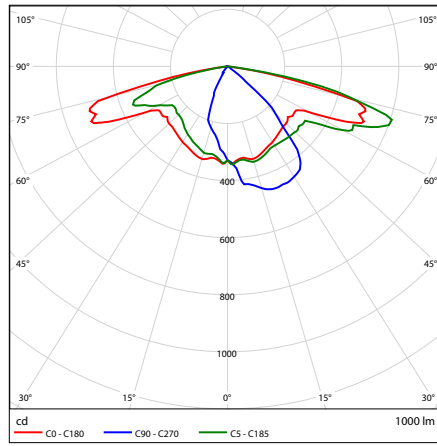

AB

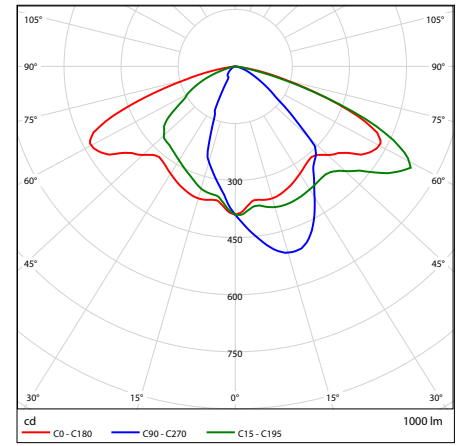

AB5

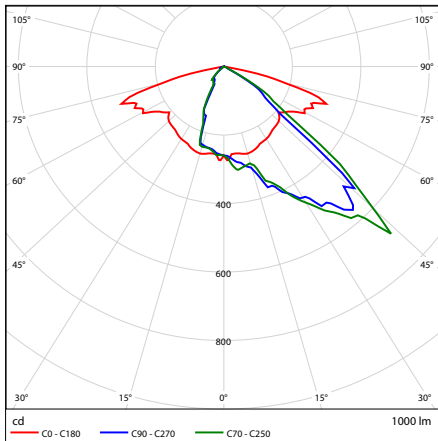

AC

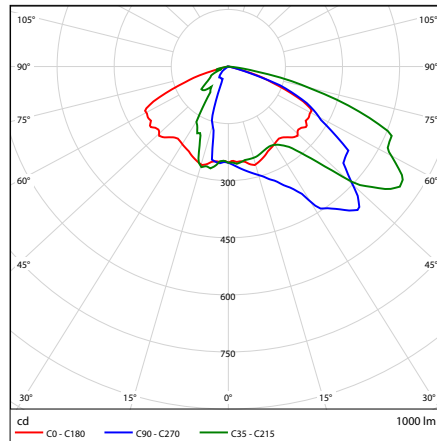

AD

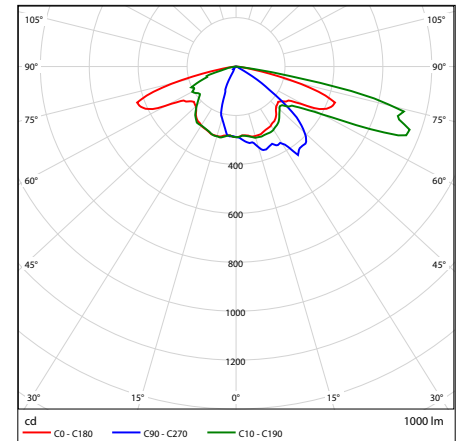

AE

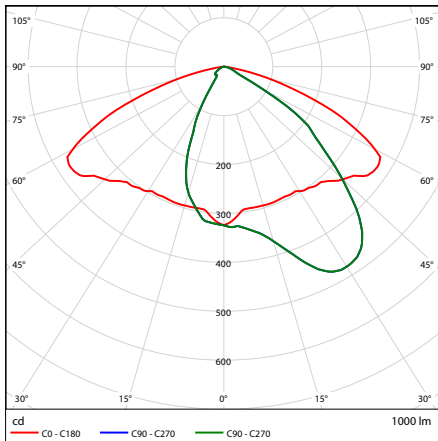

AE5

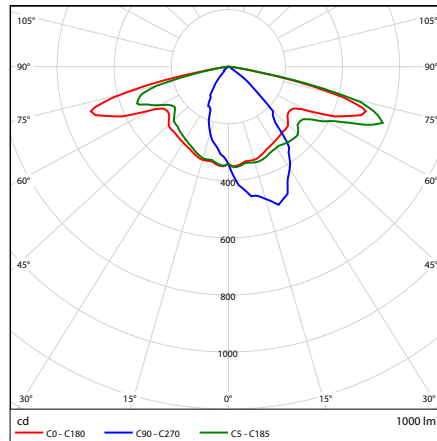

AQ

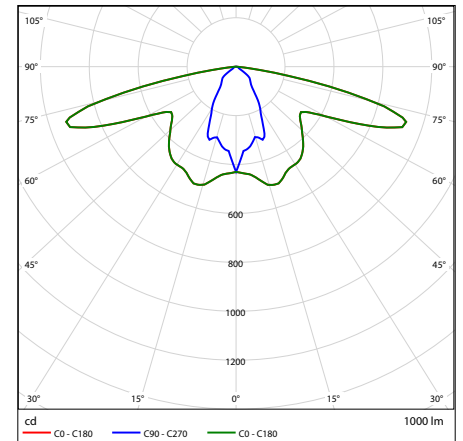

SA

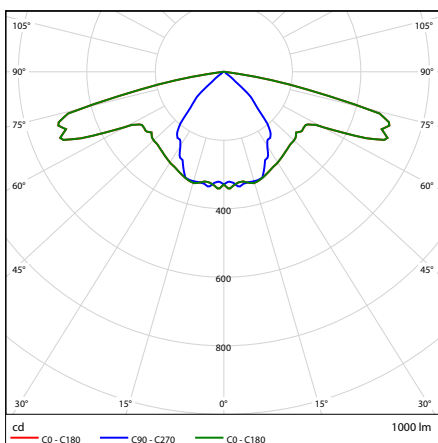

SB

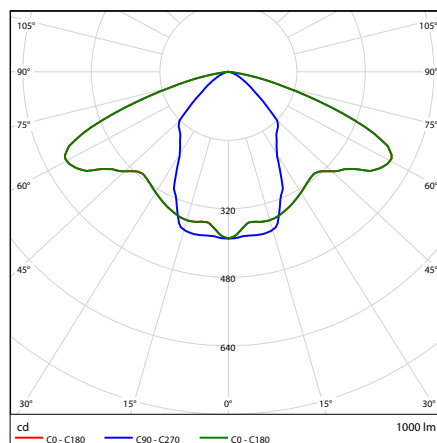

SB5

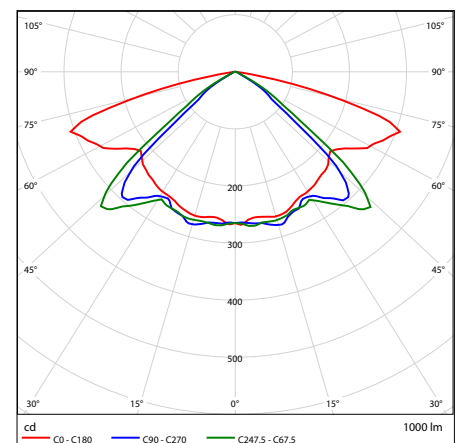

SC

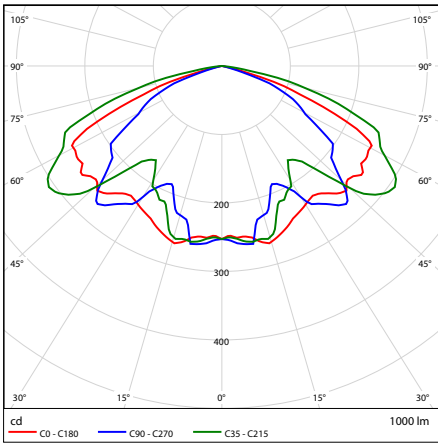

SD

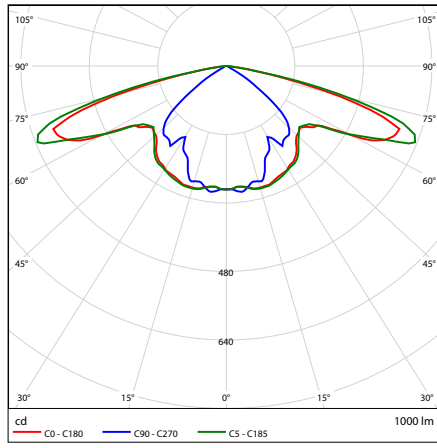

SE

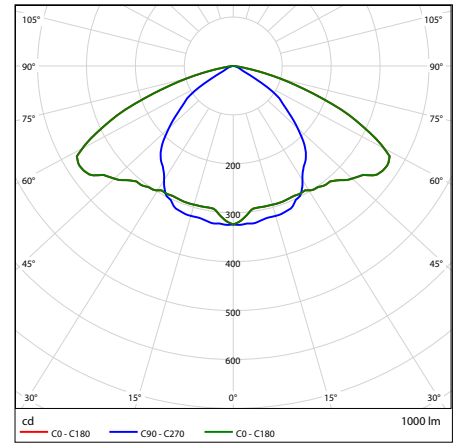

SE5

Dimensions (mm)

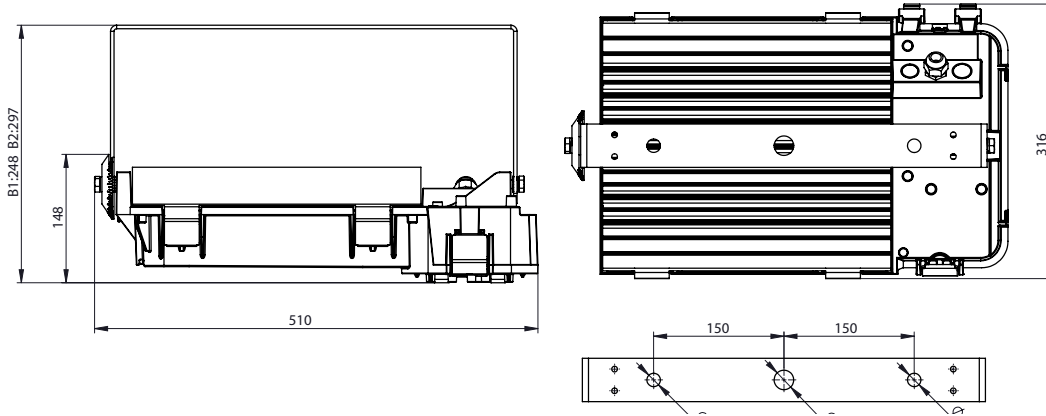

Double version - Parallel (B3) 19.5 kg

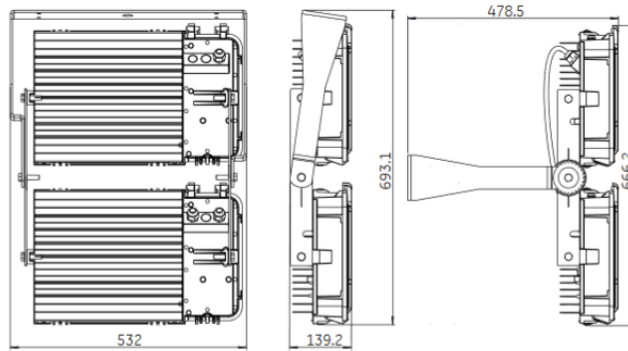
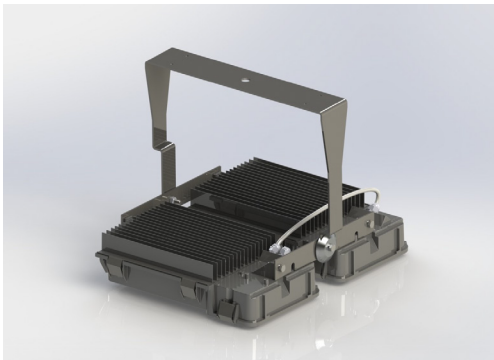

Double version - Inline (B4) 15.4kg

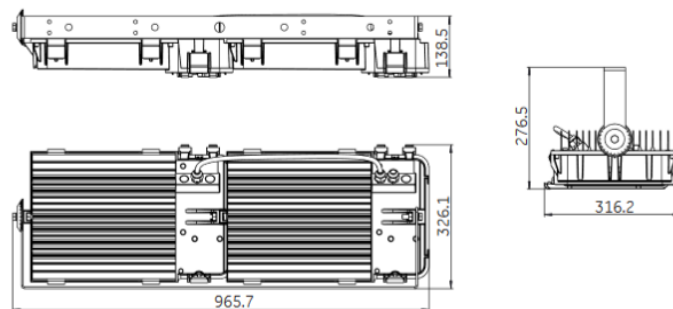
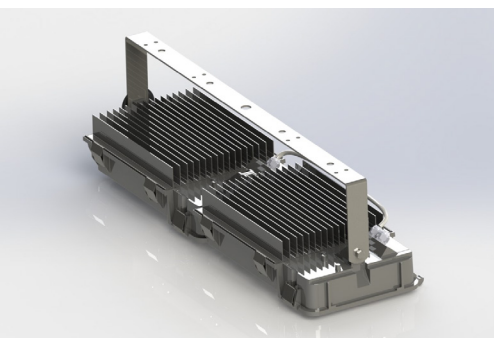

Order logic

1 module

Family	Gen.	Front glass	Optics	Input-Power (W) *	CCT [K]	Control	Accessories	IEC protection class	Precabbling	Mounting	Customer ****
TLBt	4	F	A B C D E Y B5 E5	32-90 - 35W-90W	30 - 3000 40 - 4000 50 - 5000	N - No control D - DALI AMPxxx - Output current amplitude dimming** Wxxx - LineSwitch** Yxxx - DynaDIM** NLxxx - No control + CLO** DLxxx - DALI + CLO** WLxxx - LineSwitch + CLO** YLxxx - DynaDIM + CLO**	ST- 10kV Surge immunity (built-in the driver) SP - 10kV Extra Surge protection	C1 - Class I C2 - Class II	N - without precabbling Px - Precabbed with x** m MCx - Mounted Con- nector***	B1 - Short bracket for ceiling mounting B2 - Long bracket for wall mounting	XXX

Example: TLBt/4/F/Y/90/40/D/ST/C1/N/B1

* Input power of the Luminaire can be programmed by the manufacturer in 1W steps within the marked range.

** x is integer:0-9

*** if X is "2" it means two extra connector pairs for DALI loop-in loop out, if "0" there is no DALI loop. This option is not valid with C2.

**** Optional customer/project specific product identifier. It has no impact on technical features. Leave it blank if it is standard.

2 modules

Family	Gen.	Front glass	Optics	Input-Power (W) *	CCT [K]	Control	Accessories	IEC protection class	Precabbling	Mounting	Customer ****
TMBt	4	F	AA - (Asym) AB - (Asym) AC - (Asym) AD - (Asym) AE - (Asym) AQ - (Asym) AB5 - (Asym) AE5 - (Asym) SA - (Sym) SB - (Sym) SC - (Sym) SD - (Sym) SE - (Sym) SB5 - (Sym)) SE5 - (Sym)	130 - 175 130W-175W ***** 260 - 350 260W-350W *****	30 - 3000 40 - 4000 50 - 5000	N - No control D - DALI AMPxxx - Output current amplitude dimming** Wxxx - LineSwitch** Yxxx - DynaDIM** NLxxx - No control + CLO** DLxxx - DALI + CLO** WLxxx - LineSwitch + CLO** YLxxx - DynaDIM + CLO**	ST- 10kV Surge immunity (built-in the driver) SP - 10kV Extra Surge protection	C1 - Class I C2 - Class II	N - without precabbling Px - Precabbed with x** m MCx - Mounted Con- nector***	B1 - Short bracket for ceiling mounting B2 - Long bracket for wall mounting B3 - Parallel bracket for double version B4 - Inline bracket for double version	XXX

Example: TMBt/4/F/AA/130/40/D/ST/C1/N/B1

* Input power of the Luminaire can be programmed by the manufacturer in 1W steps within the marked range.

** x is integer:0-9

*** if X is "2" it means two extra connector pairs for DALI loop-in loop out, if "0" there is no DALI loop. This option is not valid with C2.

**** Optional customer/project specific product identifier. It has no impact on technical features. Leave it blank if it is standard.

***** This wattage range will be available only for single version with B1 or B2

***** This wattage range will be available only for double version with B3 or B4 and without ENEC.