

SMix



Product information

SMix offers an optimal solution for street lighting. Taking advantage of Tungsram's proprietary modular refractive optic system, a wide range of light distributions can be achieved. The optimized mechanical design provides simple installation, adjustability, and reliability.

Application areas



Pedestrian street



Roadways
and Highways

Driver features

- Electronic, dimmable driver: Dali, DynaDim, CLO

Performance

- Rated luminous flux range: from 5010 to 22130 lm
- Rated luminaire efficacy: from 129 to 153lm/W
- Rated median useful life and the associated rated LM factor:
L80B50 > 121.000 hours
- Rated useful life and the associated rated LM factor:
L80B10 > 115.000 hours
- Rated median useful life and the associated rated LM factor:
L90B50 > 54.000 hours
- Rated useful life and the associated rated LM factor:
L90B10 > 50.000 hours
L90B10 > 100.000 hours (Ta=12°C, 100mA max LED current)
- Rated abrupt failure value: < 10% at 100.000 hours
- Abrupt light output degradation (C) < 10 at 100.000 hours
- Photometric code: 730/559, 740/559, 750/559
- Lumen maintenance code: 9
- Rated ambient temperature (tq) related to performance for a luminaire: 25°C

*Definitions and tolerances according to IEC62722-2-1:2014

Installation and maintenance

Mounting options:

- Side mounting with coupler for 42-60 diameters and -15°, -10°, -5°, 0°, 5°, 10°, 15° tilt options
- Post top mounting with coupler for 42-60 diameters and -15°, -10°, -5°, 0°, 5°, 10°, 15° tilt options
- Side mounting with coupler for 30-48 diameters and -15°, -10°, -5°, 0° tilt options
- Post top mounting with coupler for 30-48 diameters and 0°, 5°, 10°, 15° tilt options
- U76 coupler is available on request
- Weight: 8 kg
- Recommended mounting height: 4 - 15m
- Only two hand-tools required for installing the fixture
- Storage temperature up to 85°C.
- Ambient temperature from -40°C to +50°C

Optics

Available photometric distributions:

- C: optimized for wide high traffic M class roads
- E: optimized for narrow P class roads
- F: optimized for wide P class roads
- Q: optimized for narrow high traffic M class

Rated colour rendering index > 70

Rated correlated colour temperatures*: 3000K, 4000K, 5000K
ULOR: 0

Rated initial chromaticity co-ordinate values:

- CIE(x=0.43, y=0.403) 5SDCM
- CIE(x= 0.38, y= 0.38) 5SDCM
- CIE(x= 0.34, y= 0.35) 5SDCM

Structures and materials

- Housing material: die-cast aluminium body and coupler, with stainless steel screws.
- Optic material: Optical-grade polycarbonate
- Optical cover: Tempered glass
- Colour: RAL7035
- Impact Strength: IK08 (glass) / IK09 (housing) / IK08 (Shorting Cap)

Electrical

Input voltage and frequency: 220-240V, 50-60Hz
 Class I, Class II (no ENEC)
 Surge protection: minimum 10kV/5kA
 Rated input power: 35W to 160W
 Power factor $\geq 0,9$

Standards and regulation

CE, ENEC, Directive 2014/30EU, 2014/35/EU, 2009/125/EC, 1194/2012/EU, 2011/65/EC, EN 60598, EN 62471, EN 55015, EN 61000 (61000-3-2 and 61000-3-3), EN 62493, EN 61547, IEC 62031

Other options available

Precabling, extra surge protection up to 10kV/5kA, NEMA socket with shorting cap

Typical photometrical features

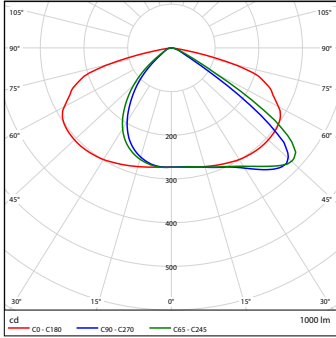

CCC

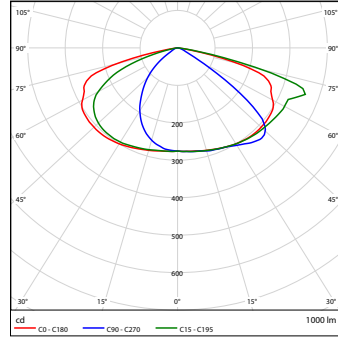

CEC

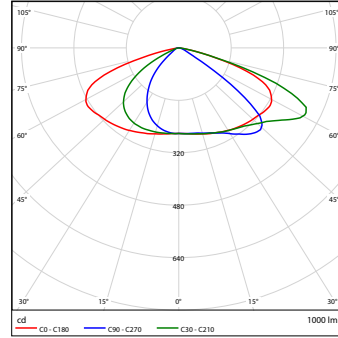

CFC

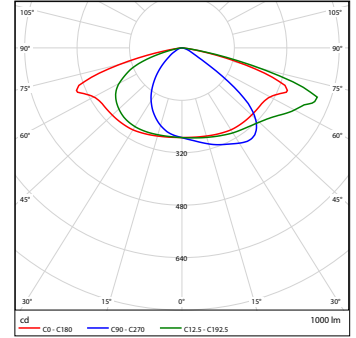

CQC

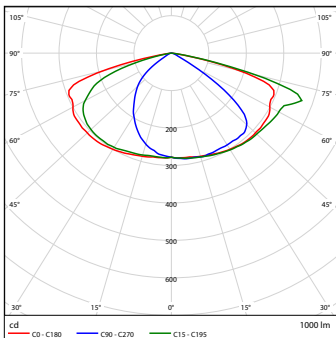

ECE

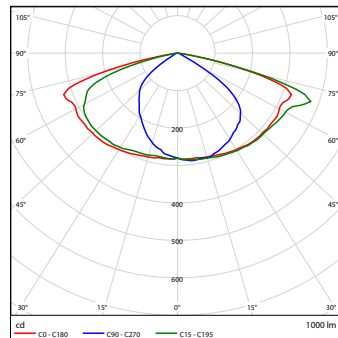

EEE

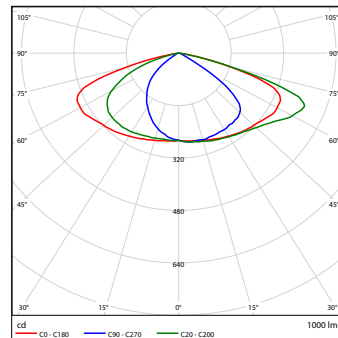

EFE

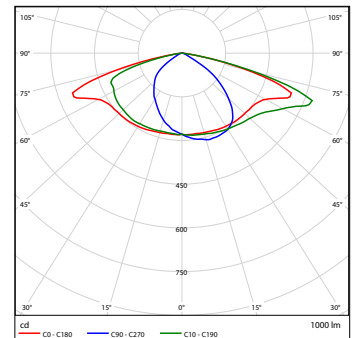

EQE

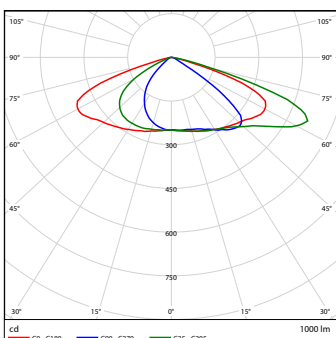

FCF

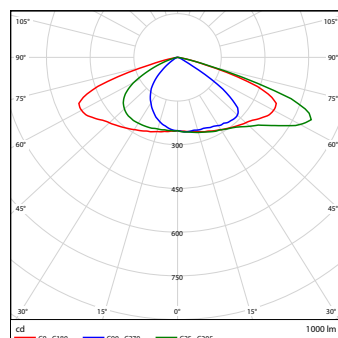

FEF

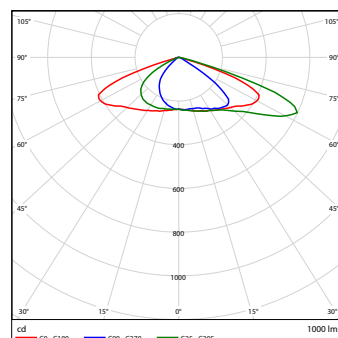

FFF

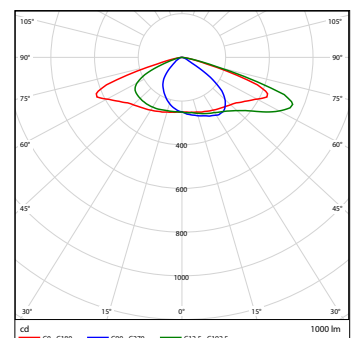

FQF

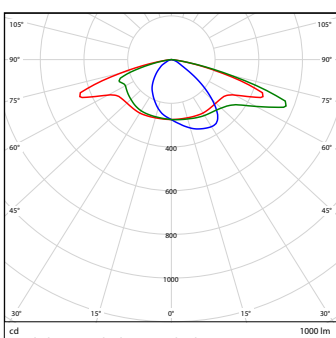

QCQ

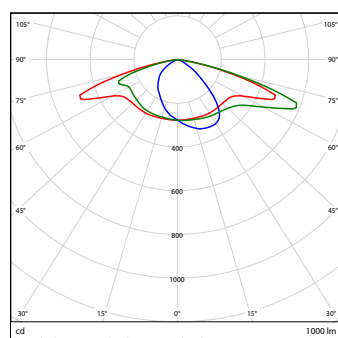

QEQ

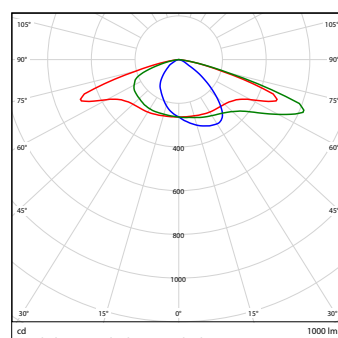

QFQ

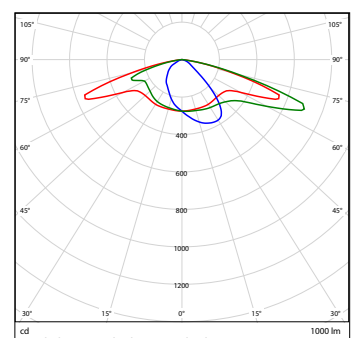

QQQ

Dimensions (mm)

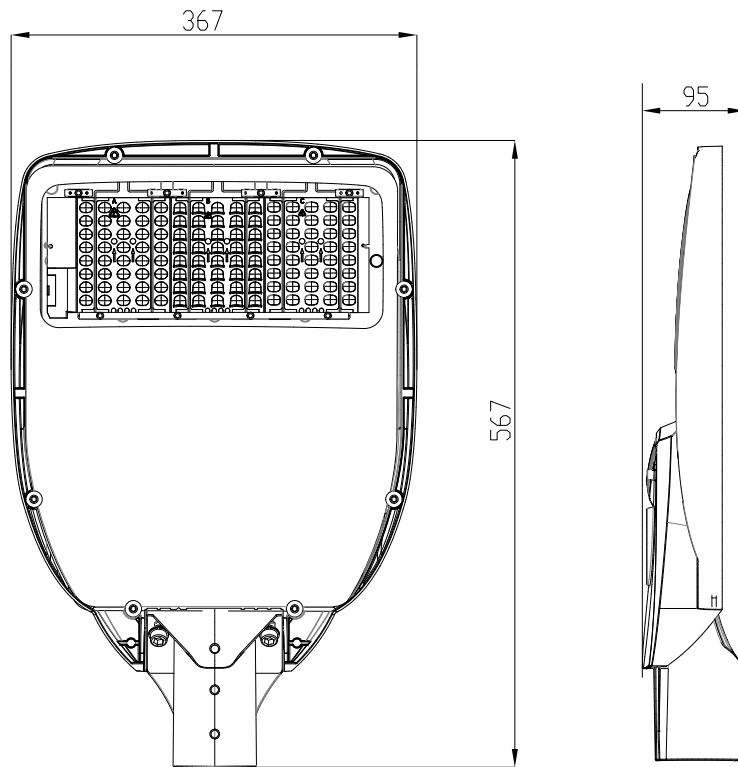

Order logic

Name	Gen.	Optics	Power Category (W) ⁽¹⁾	CCT (K)	Control	Accessories	IEC protection classes	Precabling ⁽⁵⁾	Mounting	Color	Customer ⁽⁷⁾								
SMIx	2	CFC	35-160	30 - 3000K	N - No control	ST - Standard, 10kV Surge immunity (built-in the driver, EN 61547)	C1 - Class I	PX- Pre cabling with X meters	U48 - Universal coupler 30-48 mm	R7035	XXX								
		CEC																	
		CCC																	
		FCF																	
		FEF																	
		EEE																	
		ECE																	
		EFE										40 - 4000K	Yxx - DynaDIM ⁽²⁾	SPx ⁽³⁾ - Enhanced Surge Voltage Protection	C2 - Class II ⁽⁴⁾	PCX- Pre cabling with X meters and connector	U60 - Universal coupler 42-60 mm	RXXX ⁽⁶⁾	SWE
		FFF										50 - 5000K	NLxx - No control + CLO ⁽²⁾	LSPx ⁽³⁾ - NEMA socket with Shorting Cap + Enhanced Surge Voltage Protection					A
		FQF											DLxx - DALI + CLO ⁽²⁾						
		QCQ											YLxx - DynaDIM + CLO ⁽²⁾						
		QEQ																	
		QFQ																	
		QQQ																	
EQE																			
CQC																			

Example: SMIx/2/EEE/140/40/D/ST/C1/PC3/U60/R7035

Exceptions:

⁽¹⁾ Power consumption of luminaire can be programmed by the manufacturer in 1W steps within the marked range.

⁽²⁾ x can be up to 3 characters

⁽³⁾ Leave "x" blank if it is standard (SPD). x=1 when it is built with varistors.

⁽⁴⁾ C2 is not valid with the followings: SP, LSP

⁽⁵⁾ Maximum precabling length is 10m.

⁽⁶⁾ Leave it blank if it is standard. Other RAL colors available on request

⁽⁷⁾ Optional customer/project specific product identifier. It has no impact on technical features except in case of the SWE (Sweden specific tail and shorting cap are part of the product) and A (valid only with 80W and driver current is less than 525mA). A not valid with SP1 and LSP1. Leave it blank if it is standard.