

Spinella



Product information

Introducing Spinella, Tungsram's single and multiple module roadway fixtures. From residential streets to highways, the Spinella fixture is changing the way you light your roads. Developed and produced in EMEA, Tungsram balances the technical needs of a sophisticated LED system with the functional demands of a reliable outdoor fixture for all weather conditions, while offering a platform for controls and intelligence.

Application areas



Residential



Road and street

Driver features

- Electronic, dimmable
- Constant Light Output (optional)
- Single module: from 52W to 125W
- Multiple module: from 130W to 230W
- Controls system inputs
- (Single module):** No control, Dali, DynaDIM, CLO
- (Multiple module):** No control, Dali, DynaDIM, CLO

Installation and maintenance

Mounting options:

- Side mount \varnothing 48mm-60mm
- Post top \varnothing 48mm-76mm
- Coupler can be adjusted to -15° , -10° , -5° , 0° , $+5^\circ$, $+10^\circ$ and $+15^\circ$ by 5° degree steps.
- Weight: 10,5kg (Single), 20,5kg (Multiple)
- Recommended mounting height: 6-12m (Single), 6-15m (Multiple)
- Only two hand-tools required for installing the fixture.
- Storage temperature up to 85°C .
- Ambient temperature from -40°C to $+50^\circ\text{C}$ (max 40°C for 110W product with P optics and max 30°C for 125W product with P optics)

Performance

Single module:

- Rated luminous flux: from 5,520 lm to 12,720 lm
- Rated luminaire efficacy: up to 118 lm/W at 4000K
- Photometric code: 730/559, 740/559, 750/559
- Lumen maintenance code: 9
- Rated ambient temperature (tq) related to performance for a luminaire 25°C^*
- Rated median useful life and the associated rated LM factor > 105.000 hours at L90
- Rated median useful life and the associated rated LM factor: L80B50 > 128.000 hours
- Rated median useful life and the associated rated LM factor: L80B10 > 125.000 hours
- Rated abrupt failure value < 10% at 100.000 hours
- Abrupt light output degradation (C) < 10 at 100.000 hours

Multiple module:

- Rated luminous flux: from 14000 lm to 26300 lm
- Rated luminaire efficacy: up to 121 lm/W
- Lumen maintenance code: 9
- Photometric code: 730/559, 740/559, 750/559
- Rated ambient temperature (tq) related to performance for a luminaire 25°C^*
- Rated median useful life and the associated rated LM factor: L90B50 > 105.000 hours*
- Rated median useful life and the associated rated LM factor: L80B50 > 195.000 hours
- Rated median useful life and the associated rated LM factor: L80B10 > 190.000 hours
- Rated abrupt failure value*: 20,4%** at 105.000 hours
- Abrupt light output degradation (C) < 10 at 100.000 hours

*Definitions and tolerances according to IEC 62722-2-1.

**Rated abrupt failure value depends on the configuration type.

Optics

Available photometric distributions:

- Narrow Asymmetric – medium (B)
- Asymmetric – short (C)
- Asymmetric – medium (E)
- Forward asymmetric – medium (F)
- Narrow asymmetric – short (N)
- Narrow asymmetric with backlight – short (P)
(Only for single module version)
- Narrow asymmetric – medium (R)
- Narrow asymmetric – medium (S)
- Asymmetric – short (T)
- Asymmetric – medium (U)

Rated colour rendering index:>70 at 4000K

Rated correlated colour temperatures*: 3000K, 4000K,5000K

S/P rating for : 3000K: 1.24, 4000K: 1.47, 5000K:1.71

ULOR: 0

Rated initial chromaticity co-ordinate values:

CIE(x=0.43, y=0.403) 5SDCM

CIE(x= 0.38, y= 0.38) 5SDCM

CIE(x= 0.34, y= 0.35) 5SDCM

Electrical

Input voltage and frequency: 220-240V, 50-60Hz

Class I: standard, Class II: on request

Surge protection: 10kV/5kA in class I and 6kV/3kA in class II

Rated input power: 52W to 230W

Power factor: >0.9

Standards and regulation

CE, ENEC, Directive 2014/30/EU, 2014/35/EU, 2009/125/EC 1194/2012/EU, 2011/65/EC, EN 60598, EN 62471, EN 55015, EN 61000, EN 62493, EN 61547.

Structures and materials

- Housing material: die-cast aluminium body with polyester-based powder coat, corrosion resistant screws and brackets
- Optic material: coated polycarbonate or aluminium
- Optical cover: tempered glass
- Colour: RAL7035
- All materials used in this product are WEEE and ROHS compatible.

Other options available

Precabing, extra surge protection up tp 10kV/5kA, daylight sensor

Typical photometrical features

Spinella Single module (LW)

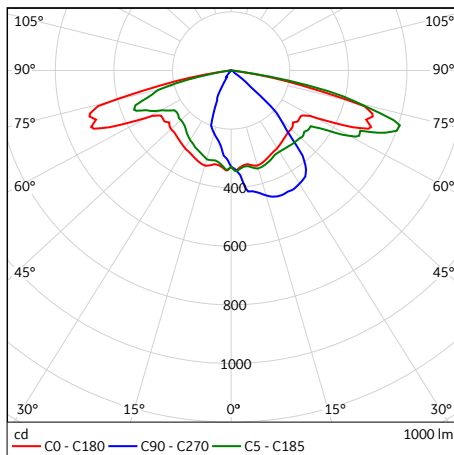

B

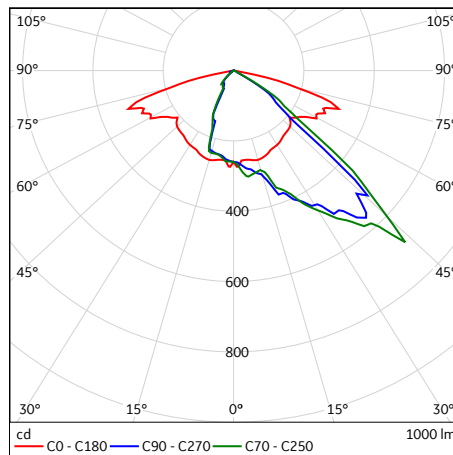

C

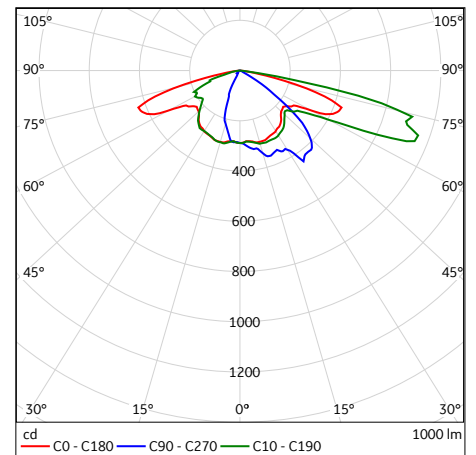

E

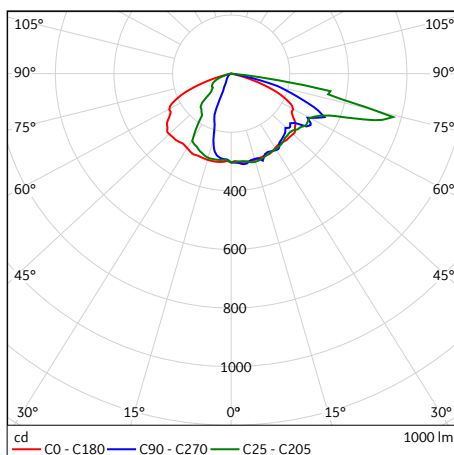

F

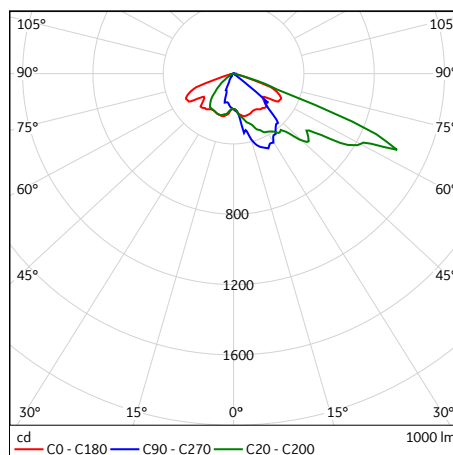

N

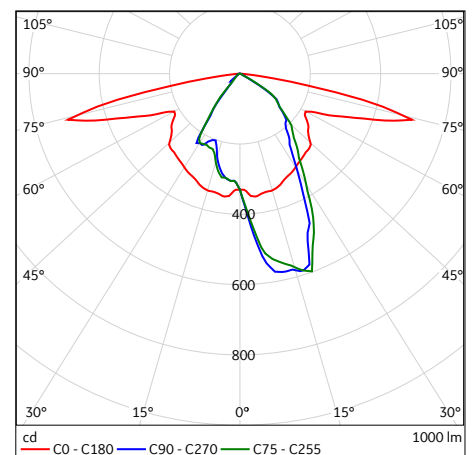

P

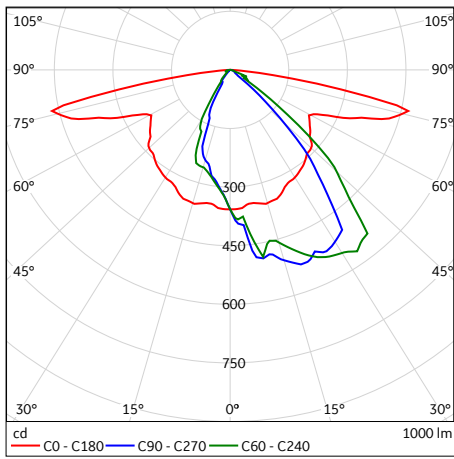

R

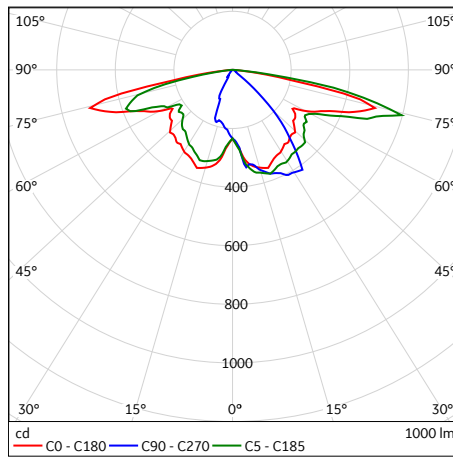

S

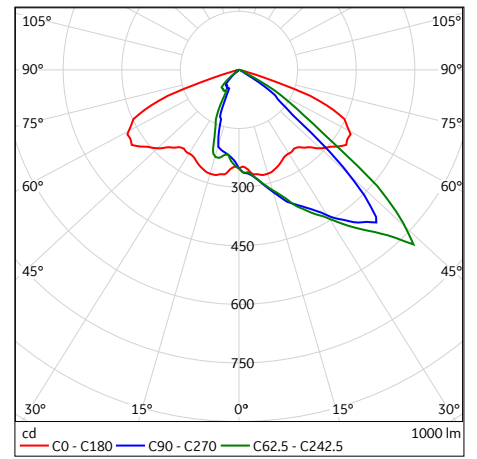

T

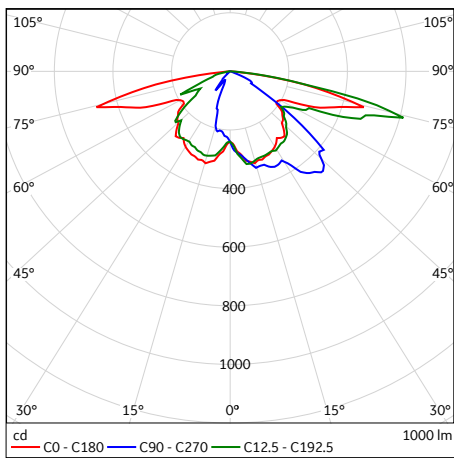

U

Spinella Multiple module (HW)

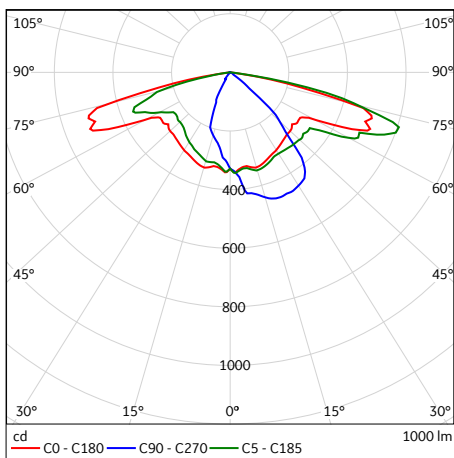

B

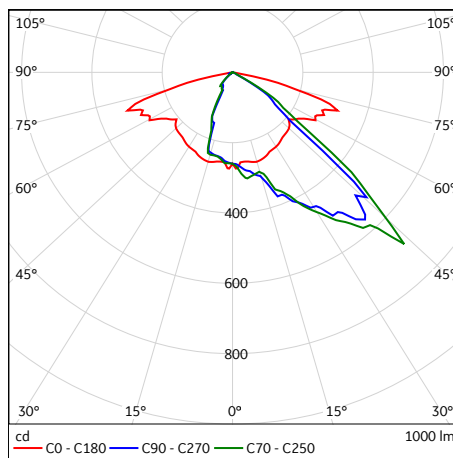

C

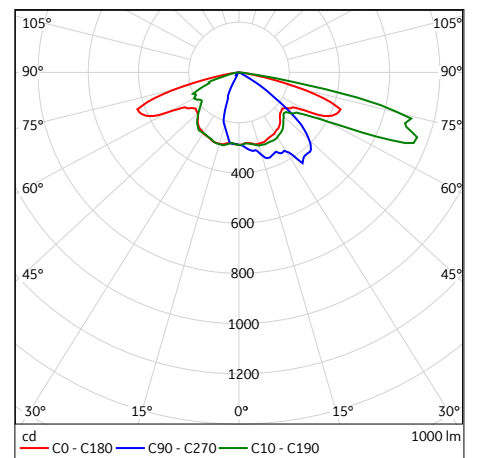

E

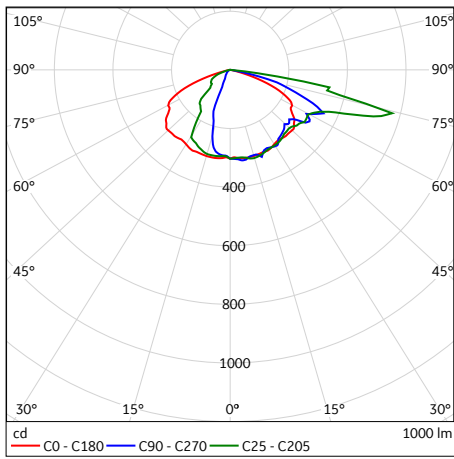

F

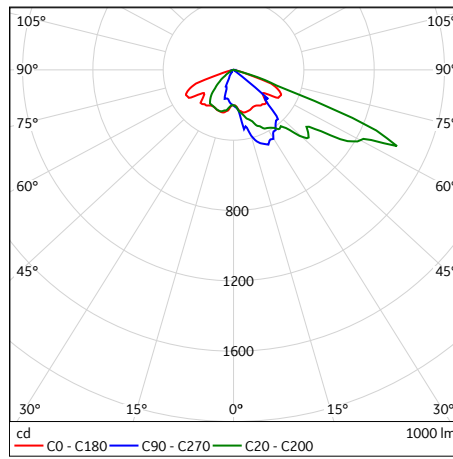

N

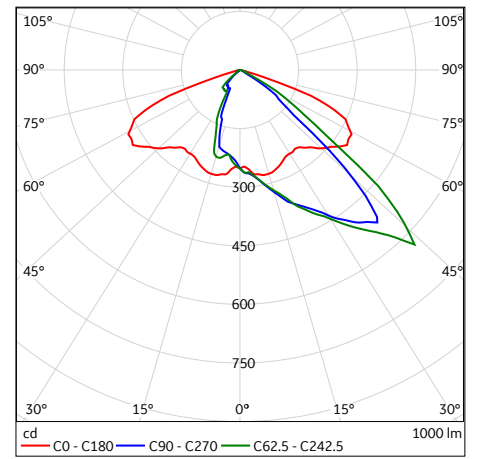

T

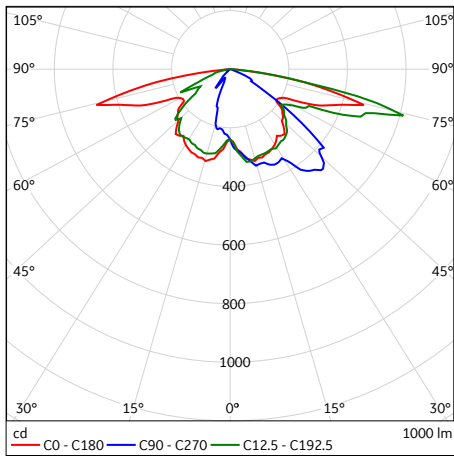

U

Dimensions (mm)

Single module

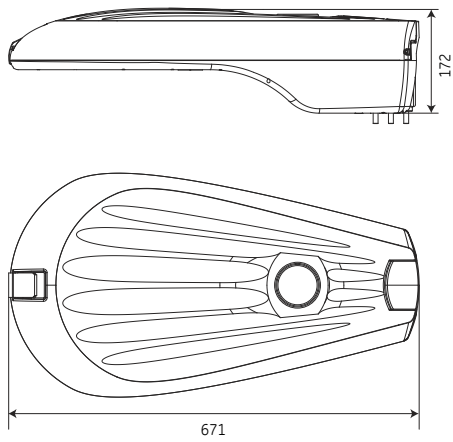

Multiple module

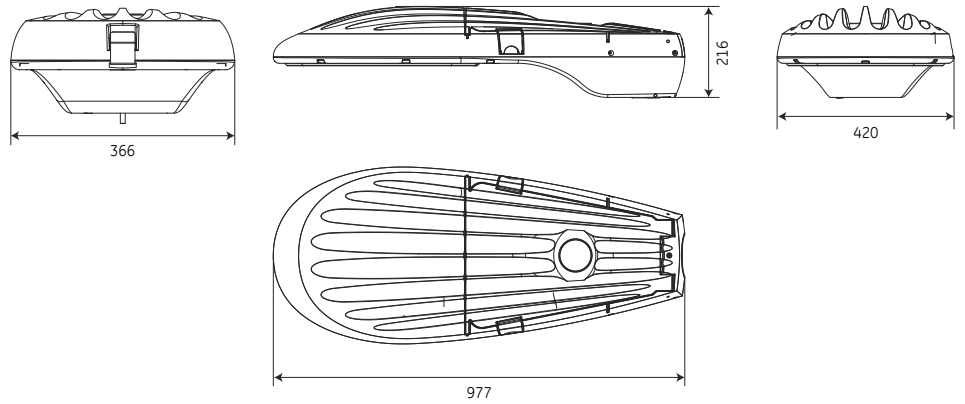

Order logic

Spinella Single module (LW)

Name	Gen.	Front Glass	Optics	Power (W)	CCT (K)	Control	Accessories	IEC Protection Classes	Precabbling	Mounting	Color
SP L	3	F-Flat Glass	B	50	30-3000	N - No control	ST - 6kV surge protection	C1 - Class I	N- No precabbling	P76 - Post top, 55-76mm	R7035
			C			D - DALI external					
E	Yxx - Dynadim	LS - 7pin NEMA socket with SP *	M3 - Minicell 35lux *	F - Fuse with SP	P50 - Post top, 42-50mm	Rxxxx					
F	NLxx - Constant Light						DLxx - DALI+CLO	YLxx - Dynadim+CLO	S50 - Side mounted, 42-50mm		
N	85	110	125								
P	100										
R	110										
S	125										
T											
U											

Example: SP L/3/F/P/100/40/Y/ST/C1/P1/S50

*MINICELL and NEMA socket are only available in Class 1 version

Spinella Multiple module (HW)

Name	Gen.	Front Glass	Optics	Power (W)	CCT (K)	Control	Accessories	IEC Protection Classes	Precabbling	Mounting	Color **
SP H	3	F-Flat Glass	B	130	30-3000	N - No control	ST - Standard type	C1 - Class I	N- No precabbling	S60 - Side mount 48-60mm	R7035
			C			D - DALI					
E	Yxx * - DynaDIM	F - Fuse	SP - Surge protection ***	P76 - Post top 76 mm							
F	NLxx * - No control + CLO				YLxx * - DynaDim + CLO	DLxx * - DALI + CLO					
N	170	190	210	230							
T	210										
U	230										

Example: SP H/3/F/B/130/40/N/ST/C1/N/P76

* x is integer: 0-9

** Other RAL colors are available on request

*** Accessory type can not be used with C2 protection class