

Okapi



Product information

The perfect combination between the aesthetic and functionality makes this luminaire the perfect solution for the replacement of luminaires with low energy efficiency and important light nuisances. Ideal for efficient lighting of walkways, parks & gardens up to 6m high. The advanced LED optical system used in the Okapi LED improved horizontal and vertical uniformity, reduced glare and improved lighting controls.

Application areas



Pedestrian street



Parks



Road & street

Driver features

- Electronic, programmable & dimmable
Control system inputs: DALI, Analogue (0-10V) and
- Clock dimming

Structures and materials

- Housing material: die-cast aluminium body with polyester-based powder coat, corrosion resistant screws and brackets
- Optic material: coated polycarbonate or aluminium
- Optical cover: tempered glass
- Colour: grey 150 sable
- All materials used in this product are WEEE and ROHS compatible.

Electrical

Input voltage and frequency: 220-240V, 50-60Hz
Class I: standard, Class II: on request
Surge protection: minimum 6kV/4kA
Rated input power: 15W to 55W
Power factor: >0.9 (at nominal power above 25W)

Installation and maintenance

Mounting options:

- Side-mounting \varnothing 48-60 mm
- Post top mounting \varnothing 48-76 mm
- Decor Arm \varnothing 48-60 mm
- Weight: 12 kg
- Recommended mounting height: 6 - 10m
- Storage temperature up to 85°C.
- Ambient temperature from -40°C to +50°C

Optics

Available photometric distributions:

- Narrow asymmetric- medium (B)
- Asymmetric- short (C)
- Asymmetric- medium (E)
- Forward asymmetric- medium (F)
- Narrow asymmetric- short (N)
- Narrow asymmetric with backlight- short (P)
- Asymmetric short (T)

Rated colour rendering index: >70

Rated correlated colour temperatures*: 3000K, 4000K, 5000K
S/P rating for : 3000K: 1.24, 4000K: 1.47, 5000K: 1.71
ULOR: 0

Rated initial chromaticity co-ordinate values:

CIE(x=0.43, y=0.403) 5SDCM
CIE(x= 0.38, y= 0.38) 5SDCM
CIE(x= 0.34, y= 0.35) 5SDCM

Performance

- Rated luminous flux range : from 1410 to 5820
 - Rated luminaire efficacy: Up to 110lm/W at 4000K
 - Photometric code: 730/559, 740/559, 750/559
 - Rated median useful life and the associated rated LM factor:
L80B50 > 111.000 hours
 - Rated median useful life and the associated rated LM factor:
L80B10 > 105.000 hours
 - Rated abrupt failure value: 5,57%
 - Lumen maintenance code: 8
 - Rated ambient temperature (tq) related to performance
for a luminaire: 25 C
 - ULOR: 0
- *Definitions and tolerances according to IEC62722-2-1:2014

Standards and regulation

CE, ENEC, Directive 2004/108/EC, 2006/95/EC, 2009/125/EC, 1194/2012/EU, 2011/65/EC, EN 60598, EN 62471, EN 55015, EN 61000, EN 62493, EN 61547

Other options available

Precabing, extra surge protection up to 10kV/5kA

Typical photometrical features

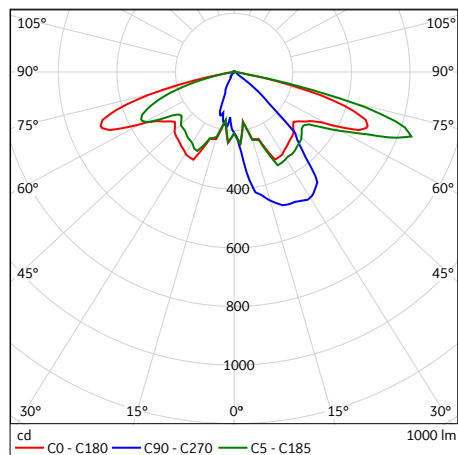

B FLAT ARM

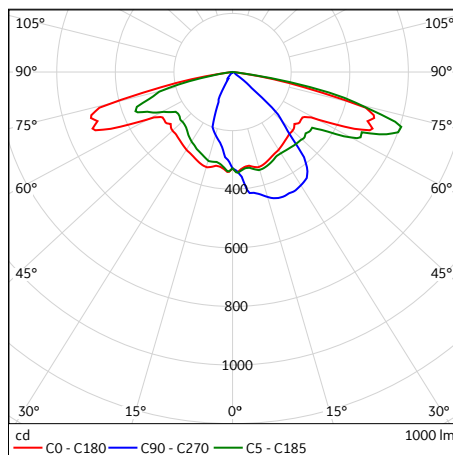

B FLAT

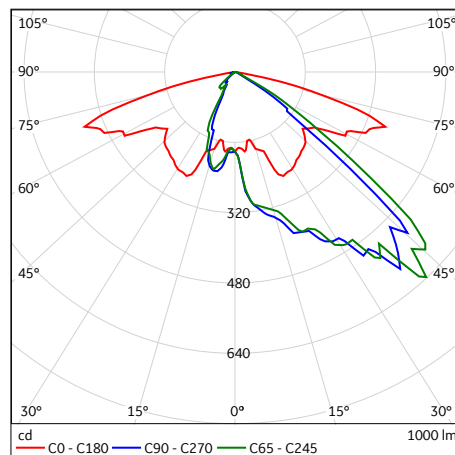

C FLAT ARM

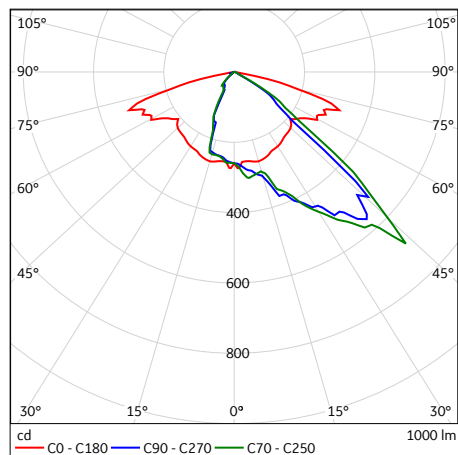

C FLAT

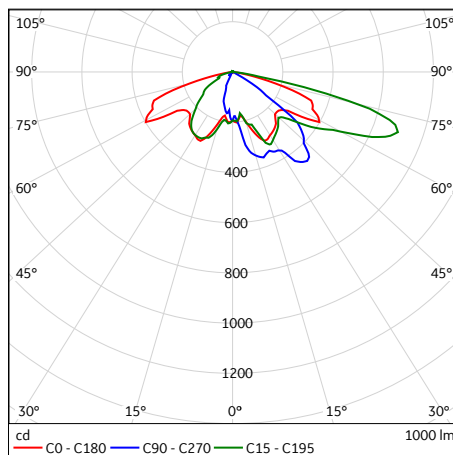

E FLAT ARM

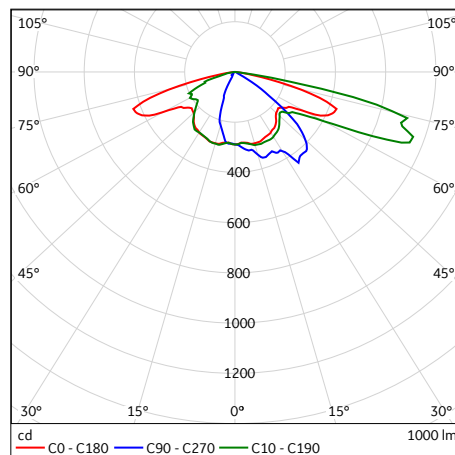

E FLAT

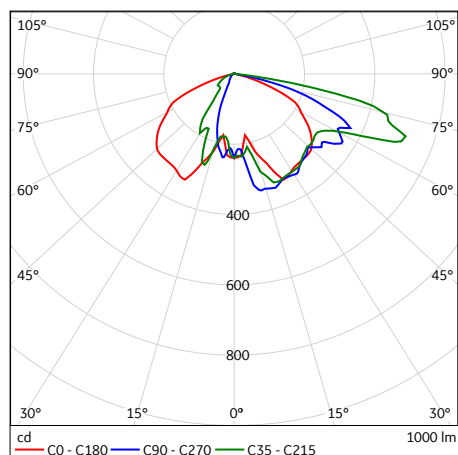

F FLAT ARM

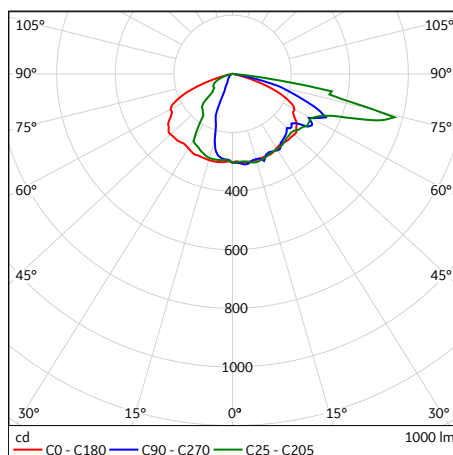

F FLAT

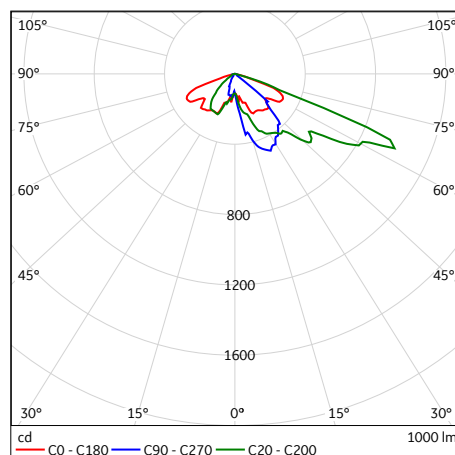

N FLAT ARM

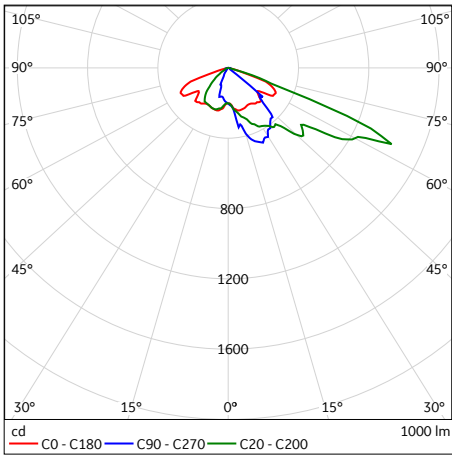

N FLAT

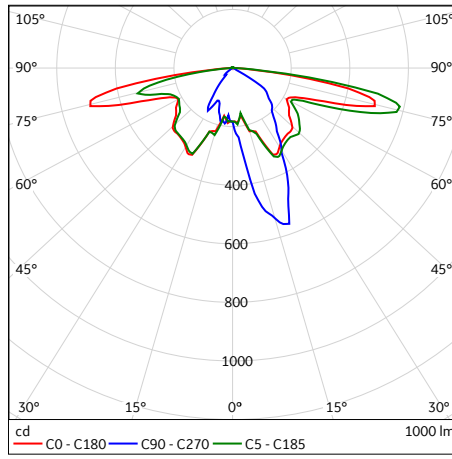

P FLAT ARM

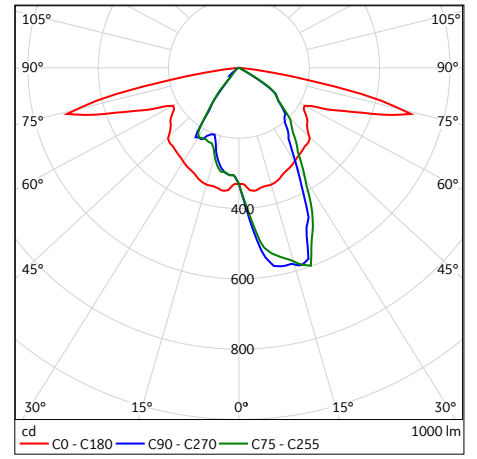

P FLAT

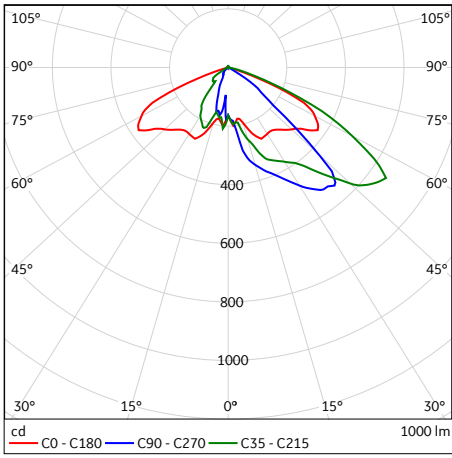

T FLAT ARM

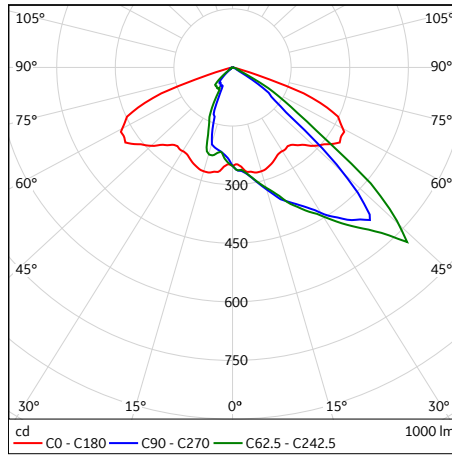

T FLAT

Dimensions (mm)

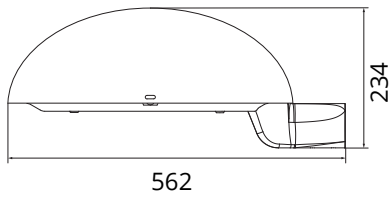

Side mounting

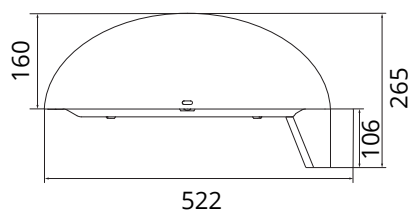

Standard post top

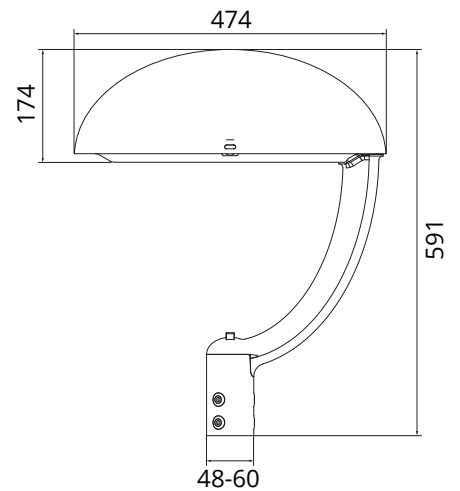

Decorative arm

Order logic

Name	Gen.	Front Glass	Optics	Power (W)	CCT (K)	Control	Accessories	Precabbling ²	Arm type	Color ³
OK L	2	F-Flat Glass	B C E F N P T	15 20 30 43 55	30-3000 40-4000 50-5000	N - No control D - DALI C - Clockdim A - 1-10V analog	ST - Standard type SP - Surge voltage Potection F - Fuse ¹	N - No precabbling PXX - Precabbling with XX meters	N60 - Decorative arm Ø 48-60mm P60 - Post top Ø 48-60mm P76 - Post top Ø 76mm S60 - Side mount Ø 48-60mm	G150S Rxx

Example: OK L/2/F/B/15/40/N/ST/C1/N/S60

¹ Only with IEC Class I

² In case of precabbling, please sign the lenght of the precabbling

³ Standard color is Gris150 , in case of other color have to sign the exactly RAL code number Rxxxx