

AMix



Product information

The AMix, Tungsram's latest LED canopy fixture, provides a flexible and rapid installation solution for petrol stations, high bays, low bays, parking garages, industrial areas and other area lighting application areas. The AMix is ideally suited both for replacing traditional fixtures such as HID luminaires and for new installations.

Application areas



High bay /
Low bay



Parking garages /
Petrol station



Floodlighting



Industrial areas

Driver features

- Electronic, dimmable driver
- 150W with DALI control
- Power factor > 0,97

Structures and materials

- Housing material: die-cast and sheet metal aluminium body, stainless steel screws and brackets
- Surface finish: polyester powder coat
- Colour: RAL9003
- Optical cover: tempered low-iron glass
- All materials used in this product are WEEE and ROHS compatible.

Performance

- Rated luminous flux range: 7560 to 18,750 lm
- Rated luminaire efficacy: Up to 146 lm/W
- Rated median useful life and the associated rated LM factor L80B50: > 120.000 hours
- Rated useful life and the associated rated LM factor L90B10: > 105.000 hours
- Rated abrupt failure value: <10% at 100.000 hours
- Photometric code: 730/559, 740/559
- Lumen maintenance code: 9
- Rated ambient temperature (tq) related to performance for a luminaire: 25°C

Installation and maintenance

Mounting options:

- Bezel, surface mount and flood
- Weight: 9kg
- Recommended mounting height: 4-6 m
- Ambient operating temperature: -40°C to +50°C
- Storage temperature: up to 85°C

Optics

Available photometric distributions:

- AC - asymmetric C
- AE - asymmetric E
- AF - asymmetric F
- SC - symmetric C
- SE - symmetric E
- SF - symmetric F
- CC - circular C
- CE - circular E
- CF - circular F

Rated colour rendering index >70

Rated correlated colour temperatures*: 3000K, 4000K
ULOR: 0

Rated initial chromaticity co-ordinate values:

- 3000K: CIE(x= 0.43, y= 0.403) 5SDCM
 - 4000K: CIE(x= 0.38, y= 0.38) 5SDCM
- S/P rating for 3000K: 1,33; 4000K: 1,56

Electrical

Input voltage and frequency: 220-240V, 50-60Hz
IEC Protection Class: Class I
Surge Immunity: 10kV
Rated input power: 55W to 146W

Standards and regulation

CE, Directive 2004/108/EC, 2006/95/EC, 2009/125/EC
 1194/2012/EU, 2011/65/EC, EN 60598, EN 62471, EN 55015,
 EN 61000, EN 62493, EN 61547.

Other options available

Pre-cabling with quick connector
 Other RAL colours available on request

Typical photometrical features

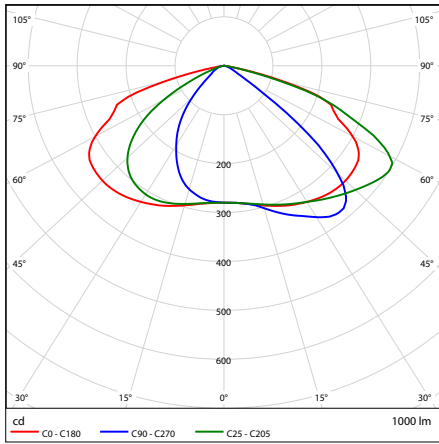

AC - Asymmetric C

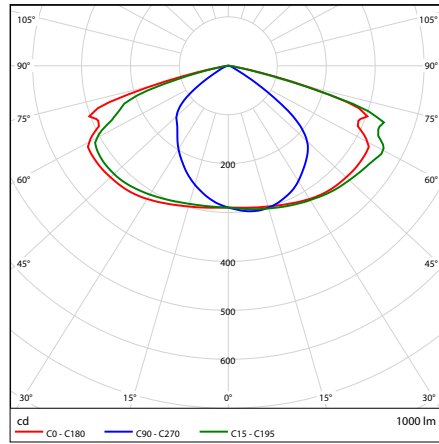

AE - Asymmetric E

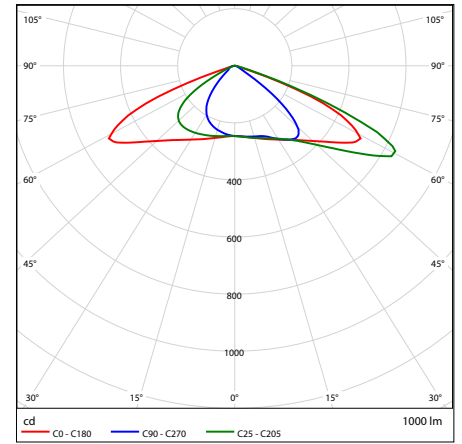

AF - Asymmetric F

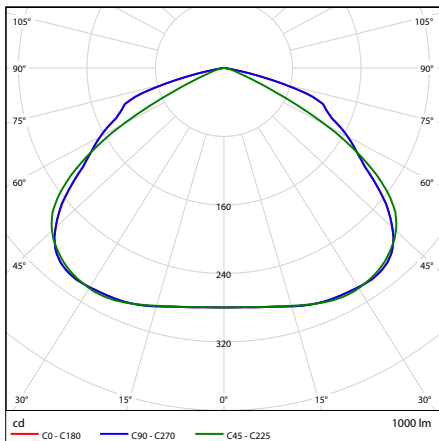

CC - Circular C

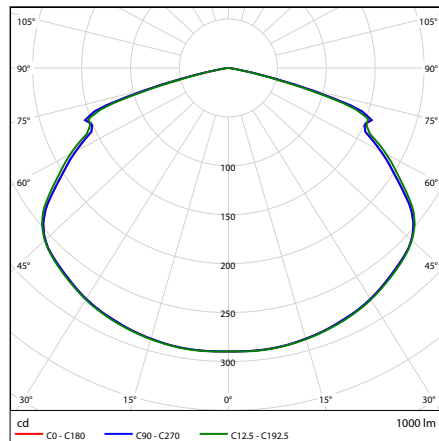

CE - Circular E

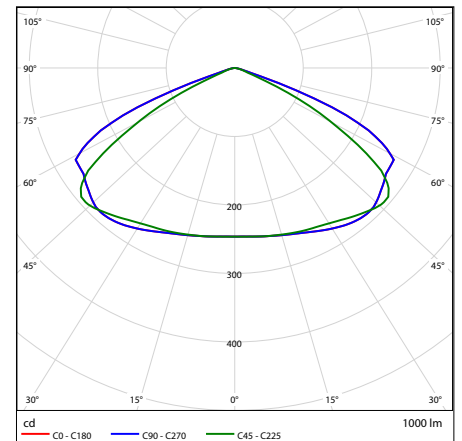

CF - Circular F

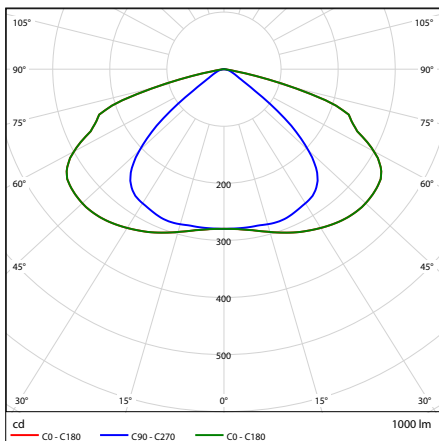

SC - Symmetric C

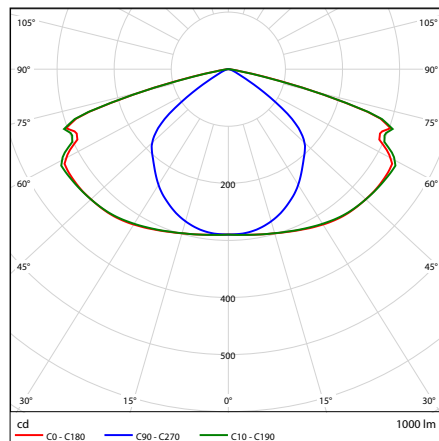

SE - Symmetric E

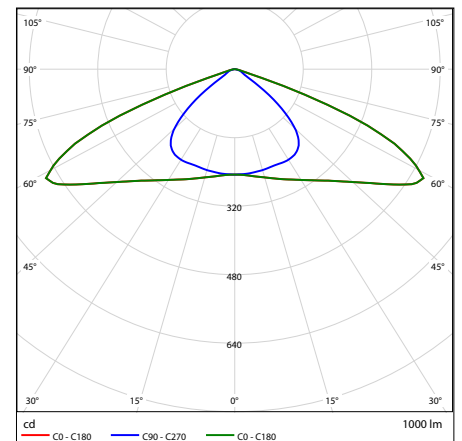

SF - Symmetric F

Dimensions (mm)

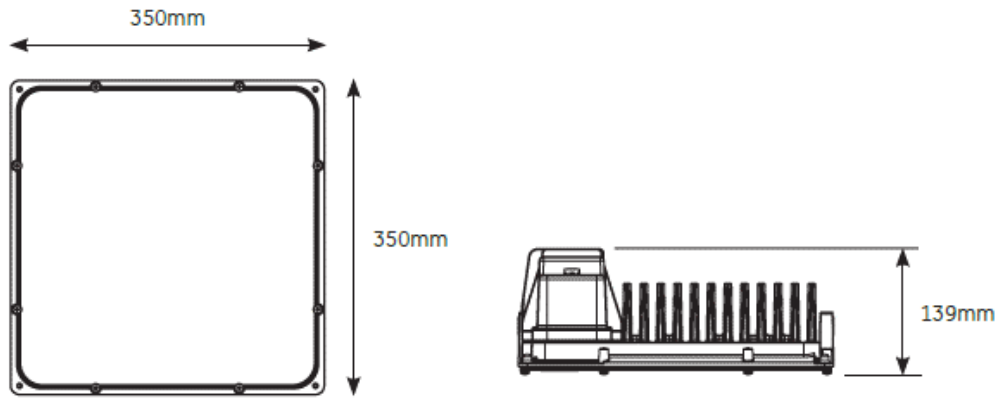

Order logic

Name	Generation	Front Glass	Optics	Power (W)	Colour code	Control	IEC Protection Classes	Precabbling	Mounting	Color
AM L	3	F-Flat Glass	AC - asymmetric C AE - asymmetric E AF - asymmetric F SC - symmetric C SE - symmetric E SF - symmetric F CC - circular C CE - circular E CF - circular F	55 65 80 100 120 150	730-3000K 740-4000K	N - No control D - DALI	C1 - Class I	N- No precabbling P- Precabbling PC- Precabbling with quick connector	B - Bezel SM - Surface Mount FL - Flood-light N - no mounting kit	R9003

Example: AM L/3/F/CC/100/740/D/C1/N/B

Bezel is sold as an accessory, SKU: 529723 ACOP BEZEL 390X390 AMIx
R9003 is the standard colour, other colours available on request