

AMix



Product information

The AMix, Tungsram Lighting's latest LED canopy fixture, provides a flexible and rapid installation solution for petrol stations, high bays, parking garages, industrial areas and other area lighting application areas. The AMix is ideally suited both for replacing traditional fixtures such as HID luminaires and for new installations.

Application areas



Industrial High bay



Parking garages



Floodlighting



Petrol station

Driver features

- Electronic, dimmable driver
- 100W&150W with 0-10V or DALI control.

Structures and materials

- Housing material: die-cast and sheet metal aluminium body, stainless steel screws and brackets
- Surface finish: polyester powder coat
- Colour: RAL9003
- Optical cover: tempered low-iron glass
- All materials used in this product are WEEE and ROHS compatible.

Performance

- Rated luminous flux range: 4,670 to 18,830 lm
- Rated luminaire efficacy: Up to 134lm/W
- Rated median useful life and the associated rated LM factor: L80B50: > 189.000 hours
- Rated median useful life and the associated rated LM factor: L80B10 > 170.000 hours
- Rated abrupt failure value: 12.8 %*
- Photometric code: 740/559, 750/559
- Lumen maintenance code: 8
- Rated ambient temperature (tq) related to performance for a luminaire: 25°C

*Definitions and tolerances according to IEC62722-2-1:2014

Installation and maintenance

Mounting options:

- Bezel, surface mount and flood
- Weight: 9kg
- Recommended mounting height: 4-6 m
- Ambient operating temperature: -40°C to +50°C
- Storage temperature: up to 85°C

Optics

Available photometric distributions:

- S25-symmetric 25°
- S35- symmetric 35°
- S55- symmetric 55°
- A25- asymmetric 25°
- A35- asymmetric 35°
- A55- asymmetric 55°
- Rated colour rendering index >70
- Rated correlated colour temperatures*: 4000K, 5000K
- ULOR: 0

Rated initial chromaticity co-ordinate values:

- CIE(x= 0.38, y= 0.38) 5SDCM
- CIE(x= 0.34, y= 0.35) 5SDCM

S/P rating for : 3000K: 1.33, 4000K: 1.56

ULOR: 0

Rated initial chromaticity co-ordinate values:

- CIE(x=0.43, y=0.403) 5SDC
- CIE(x= 0.38, y= 0.38) 5SDC

Electrical

Input voltage and frequency: 220-240V, 50-60Hz

IEC Protection Class: Class I

Surge protection: 4kV, 2kA

Rated input power: 39W to 156W

Standards and regulation

CE, ENEC, Directive 2004/108/EC, 2006/95/EC, 2009/125/EC
1194/2012/EU, 2011/65/EC, EN 60598, EN 62471, EN 55015,
EN 61000, EN 62493, EN 61547.

Other options available

Pre-cabing with quick connector
Other RAL colours available on request

Typical photometrical features

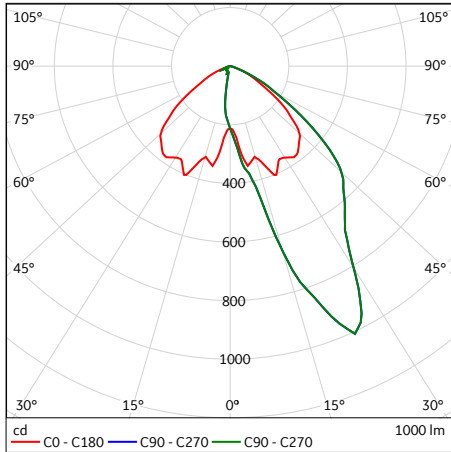

A25

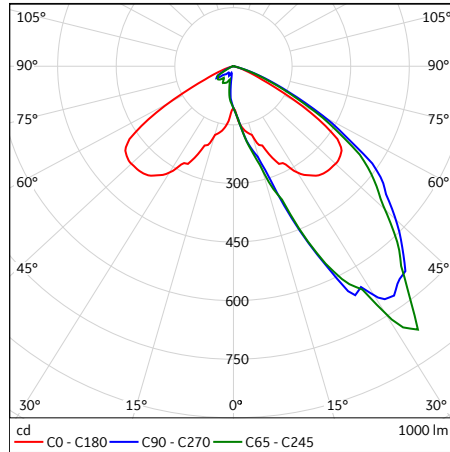

A35

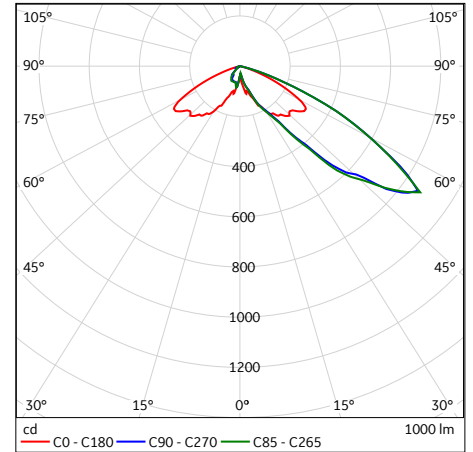

A55

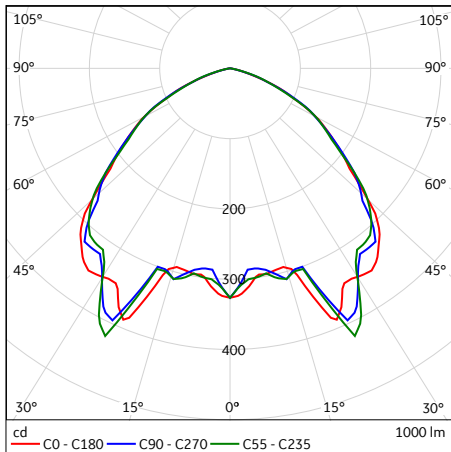

S25

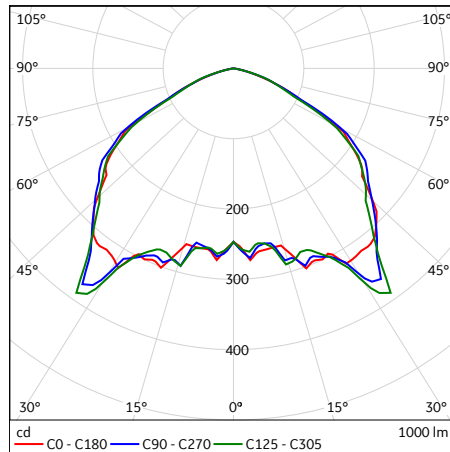

S35

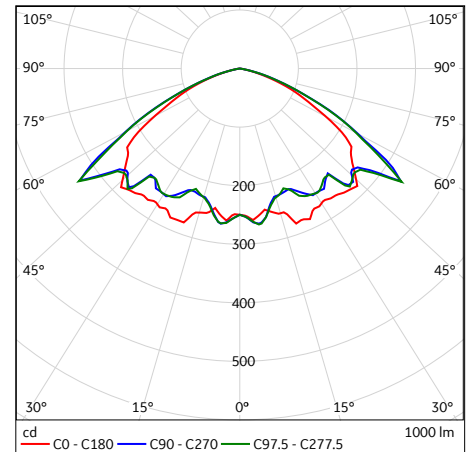

S55

Dimensions (mm)

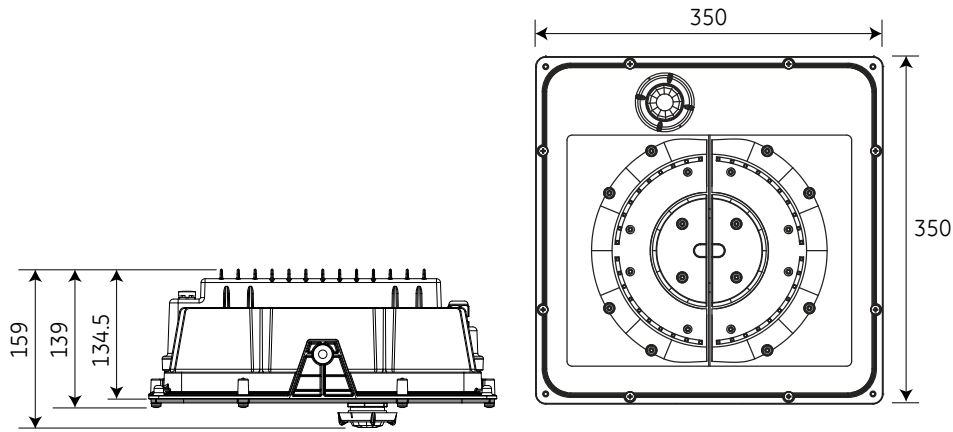

Order logic

Name	Generation	Front Glass	Optics	Power (W)	CCT (K)	Control	Accessories	IEC Protection Classes	Precabbling	Mounting	Colour
AMix	2	F-Flat Glass	S25- Symmetric 25°								
			S35- Symmetric 35°	40							
			S55- Symmetric 55°	55							
			A25- Asymmetric 25°	78							
			A35- Asymmetric 35°	80	40-4000						
			A55- Asymmetric 55°	110	50-5000						
				130		N - No control	N - No Sensor	C1 - Class I	N- No precabbling	B - Bezel	R9003
			150		D - DALI	S - With sensor		P- Precabbling	SM - Surface Mount		
			160		A - 1-10V			PC- Precabbling with quick connector	FL - Flood-light		

Example: AMix/2/F/S25/107/40/D/S/C1/N/B

Sensor is not available with DALI control. Sensor has an IK07 rating.
 Bezel is sold as an accessory, SKU: 529723 ACOP BEZEL 390X390 AMix