



SMBt



Product information

Introducing GE's brand new LED roadway lighting fixture, which makes all the advantages of LED lighting available for a wide audience. Designed to replace 35-150W HID fixtures, the SMBt is a great LED solution for minor roads, residential streets and other public spaces where modest level of illumination are required.

Application areas



Pedestrian street



Car park



Road & street

Driver features

- Electronic, dimmable (DALI) driver with autonomous dimming: 50-160W
- Minimum dimming level 20W

Structures and materials

- Housing material: die-cast aluminium body, corrosion resistant screws and brackets
- Optic material: aluminium, plastic
- Optical cover: glass
- Colour: RAL7035

Performance

- Rated luminous flux range: from 6 440 to 18 760lm at 4000K
- Rated luminaire efficacy: Up to 132lm/W at 4000K.
- Photometric code: 730/559, 740/559
- Rated median useful life and the associated rated LM factor: L80B50 > 102.000 hours
- Rated median useful life and the associated rated LM factor: L80B10 > 100.000 hours
- Rated abrupt failure value: < 10% at 100.000 hours
- Lumen maintenance code: 9
- Rated ambient temperature (tq) related to performance for a luminaire: 25°C
- Abrupt light output degradation (C) < 10 at 100.000 hours

Installation and maintenance

Mounting options:

- Side mount bracket ø42mm-60mm
- Post top bracket ø48mm-76mm
- Universal coupler side ø35mm-76mm
- Universal coupler post ø35mm-76mm
- Universal Coupler can be adjusted -15°, -10°, -5°, 0°, +5°, +10°, +15° by 5° degree steps
- Weight: 7,5 kg
- Storage temperature up to 85°C.
- Ambient temperature from -40°C to +50°C up to 140W
- +40°C up to 160W

Optics

Available photometric distributions:

- Narrow Asymmetric – medium (B, B2, B5)
- Asymmetric – short (C, C5)
- Asymmetric forward – very short (D)
- Asymmetric – medium (E, E2, E5)
- Forward asymmetric – medium (F, F5)
- Narrow asymmetric – short (N)
- Narrow asymmetric with backlight – short (P, P5)
- Narrow Asymmetric – medium (R)
- Narrow Asymmetric – medium (S)
- Asymmetric – short (T)
- Asymmetric – medium (U)
- Symmetric (Y5)

Rated colour rendering index: >70

Rated correlated colour temperatures: 3000K, 4000K

S/P rating for: 3000K: 1.33; 4000K: 1.56

ULOR: 0

Rated initial chromaticity co-ordinate values:

- CIE(x=0.43, y=0.403) 5SDCM
- CIE(x= 0.38, y= 0.38) 5SDCM

Electrical

Input voltage and frequency: 220-240V, 50-60Hz

Class I, II: standard

Surge protection: minimum 6kV/3kA, 10kV available on request

Rated input power: 52W to 158W

Standards and regulation

CE, ENEC, Directive 2014/30/EU, 2014/35/EU, 2009/125/EC
 1194/2012/EU, 2011/65/EC, EN 60598, EN 62471, EN 55015,
 EN 61000, EN 62493, EN 61547.

Other options available

Precabling, extra surge protection up to 10kV/5kA
 daylight sensor

Typical photometrical features

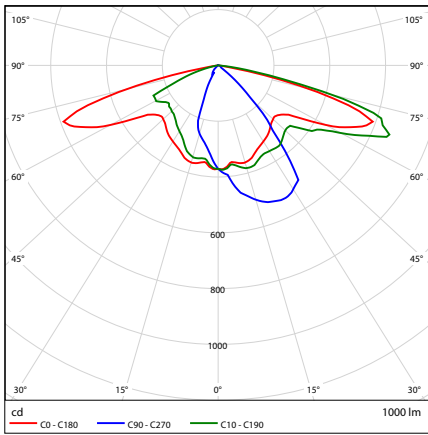

B

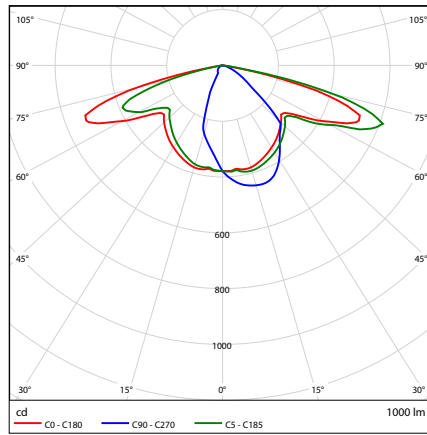

B2

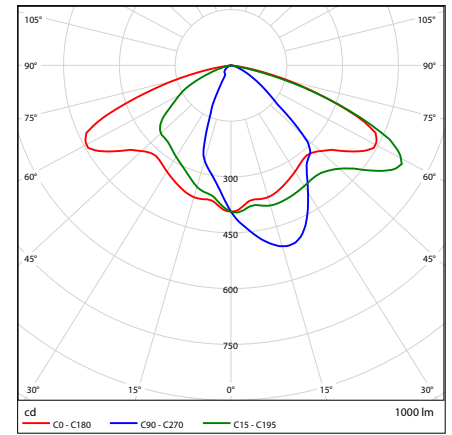

B5

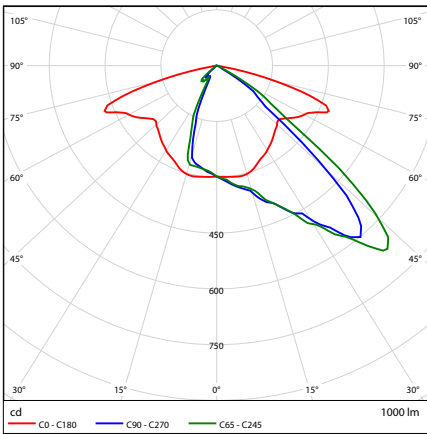

C

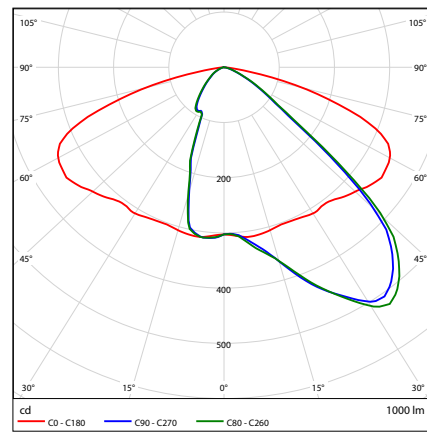

C5

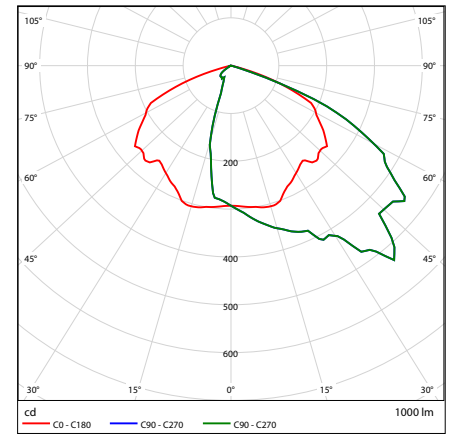

D

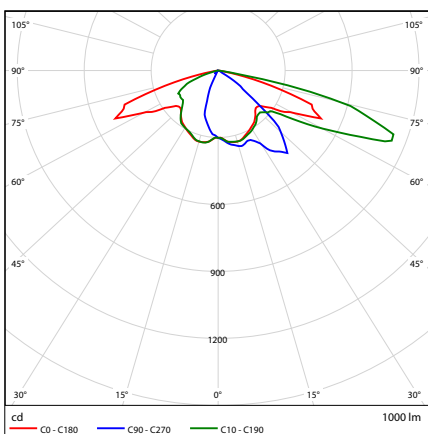

E

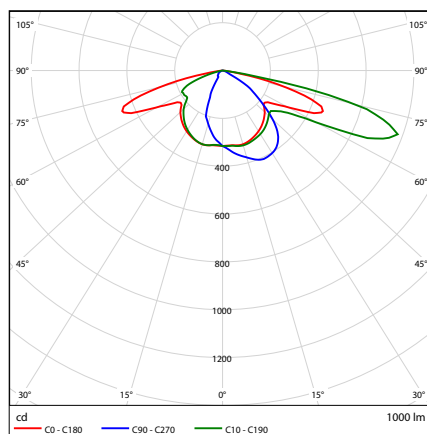

E2

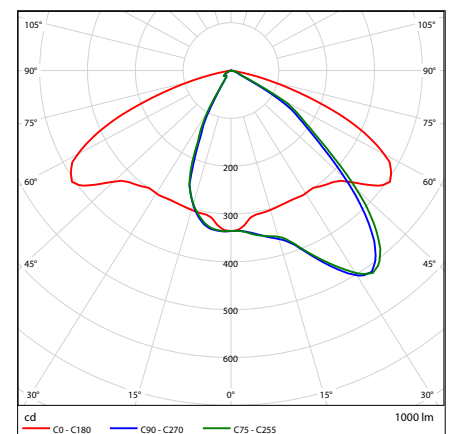

E5

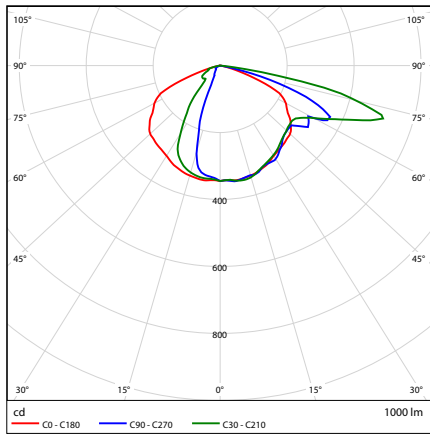

F

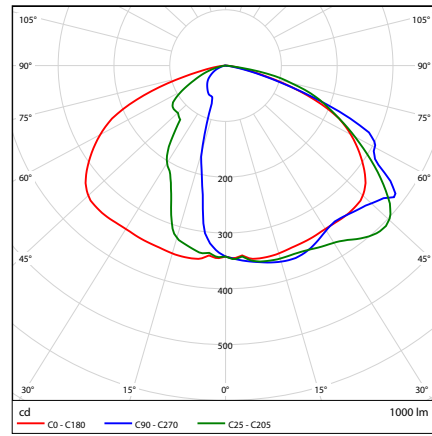

F5

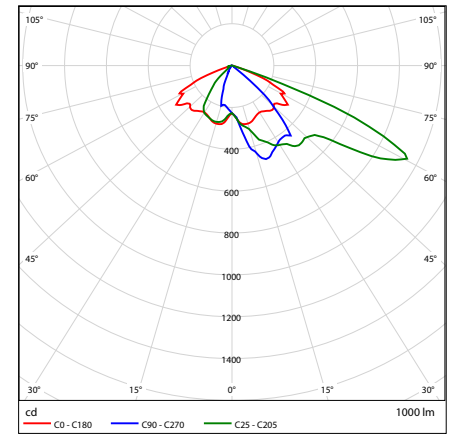

N

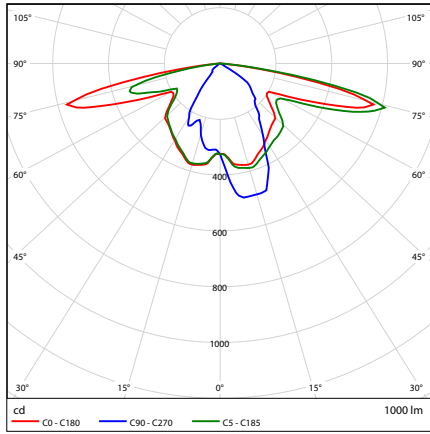

P

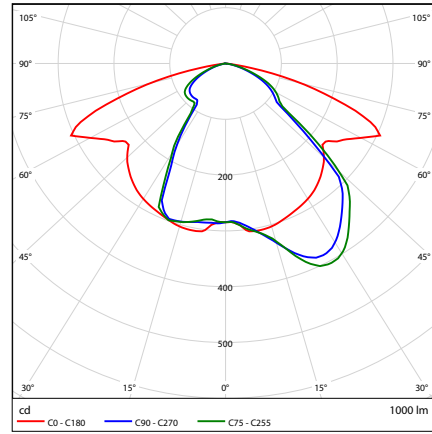

P5

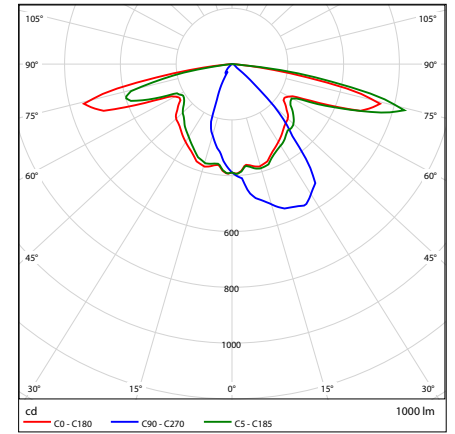

R

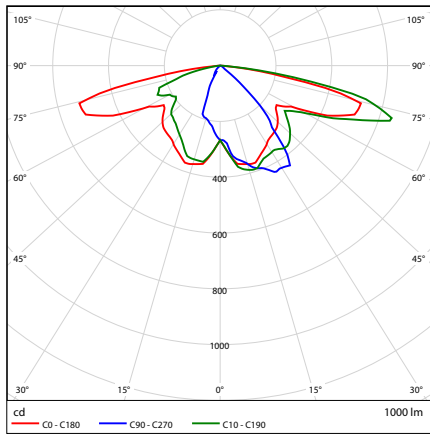

S

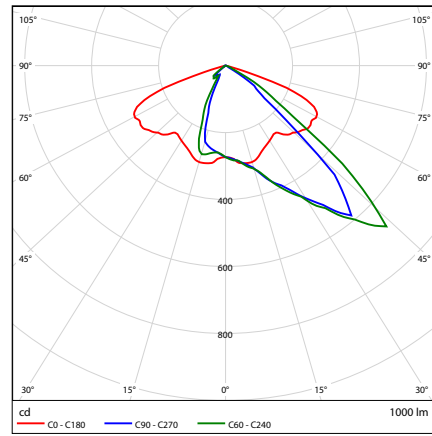

T

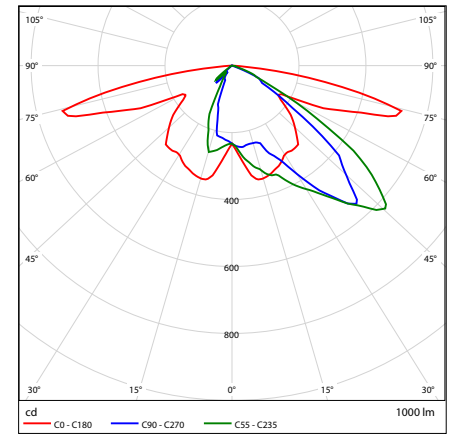

U

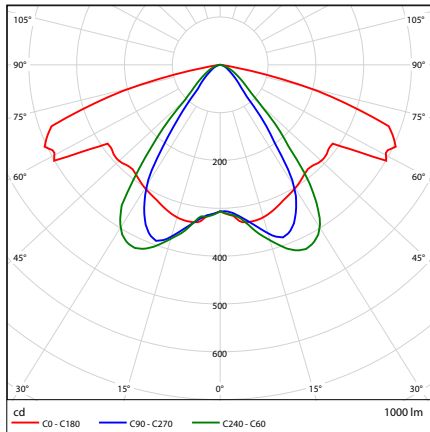

Y5

Dimensions (mm)

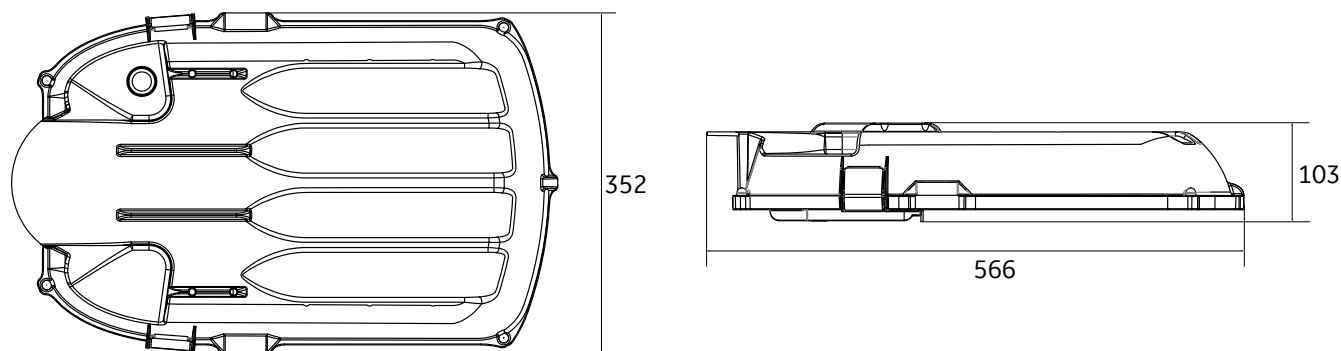

Order logic

Name	Gen.	Front Glass	Optics	Power (W)	CCT (K)	Control	Accessories	IEC Protection Classes	Precabbling	Mounting	Color
SMBT	3	F-Flat Glass	B	50 60 75 90 105 120 140 160	30-3000 40-4000	N - No control D - Dali Yxx - Dynadim* NLxx - No control with CLO DLxx - Dali with CLO YLxx - DynaDim with CLO *	ST - Standard type M3 - Minicell 35lux ** SP - Extra surge protection F - Fuse ** LS - 7 pin NEMA socket SR - Smart ready connector	C1 - Class I C2 - Class II	N- No precabbling PXX- Precabbling with XX meters	S60 - Side mount bracket 42-60mm	R7035 Rxxxx
			C							P76 - Post top bracket 48-76mm	
			D							U35 - Universal coupler with insert 35-42 mm	
			E							U50 - Universal coupler with insert 42-55 mm	
			F							U60 - Universal coupler with insert 50-60 mm	
			P							U76 - Universal coupler 55-76 mm	
			R								
			S								
			T								
			N								
			U								
			B2								
			E2								
			B5								
			C5								
			E5								
F5											
P5											
Y5											

Example: SMBT/3/F/B/75/40/N/ST/C1/N/S60

Dynadim is available from 50-160W

*Neither Minicell nor Fuse is available with C2 IEC protection class

**R7035 is a standard color, for other color please use 5 characters