

LED Downlight IP54 UGR<19



DATA SHEET



Product information

The new Tungsram IP54 Downlight range with traditional deep reflector (UGR<19) provides the perfect combination of high-efficiency, comfortable lighting and design, without compromising on light performance (colour rendering and colour uniformity). Due to the interchangeable optics (24°, 36°, 55° beam angle) it offers a wide choice of options for creating the desired ambience. IP54 range is designed for general lighting applications in offices, supermarkets, shops, schools, hotels, etc. It is also widely used for public areas, such as stairways, lobbies, receptions.

Benefits

- High luminous efficiency
- High energy savings up to 70% when compared with conventional CFL fixtures
- Easy installation and maintenance
- Affordable solution for retrofit or new installations

Fixture structure

- Die-cast aluminium housing or good heat dissipation and replaceable polycarbonate lenses
- Tested for glow wire at 650°C

Features

- 24°, 36°, 55° beam angle replaceable optic, specular reflector
- Low glare rate, UGR<19
- IP54 protection rating
- Lifetime: 70.000 hours L70B50 and 50.000 hours L80B20
- 3000K & 4000K CCT
- PF >0.9
- 80 CRI+ (90 CRI optional)
- Ambient temperature: -20°C~45°C
- Citizen LED chip
- Class II
- IK06 rating
- Aluminium die-cast housing with PC bezel and PC lenses
- Compatible with TU Emergency Converter Kit

Application areas



General lighting /
Office



Shop / Supermarket /
Hotel / Hospitality

Specification summary

Product Code	Description	System power [W]	Luminous flux [lm]	Efficacy [lm/W]	CCT [K]	CRI	Beam angle [°]	UGR (4H8H)	Weight [kg]	Body color	Product Diameter [mm]	Product Height [mm]
STATIC CONTROL												
93117198	LED DLR G1 10W 840 S 36D G	10	1 050	105	4000	≥85	36	18,3	0,23	Grey	Dia 95	54
93117197	LED DLR G1 10W 840 S 36D W	10	1 050	105	4000	≥85	36	18,3	0,23	White	Dia 95	54
93113196	LED DLR G1 18W 830 S 55D W	18	2 000	111	3000	≥85	55	17,4	0,705	White	Dia 172	90
93113197	LED DLR G1 18W 840 S 55D W	18	2 000	111	4000	≥85	55	17,4	0,705	White	Dia 172	90
93113198	LED DLR G1 23W 830 S 55D W	23	2 500	109	3000	≥85	55	18	0,705	White	Dia 172	90
93113199	LED DLR G1 23W 840 S 55D W	23	2 500	109	4000	≥85	55	17,9	0,705	White	Dia 172	90
93113200	LED DLR G1 33W 830 S 55D W	33	3 400	103	3000	≥85	55	18,8	1,135	White	Dia 228	99
93113201	LED DLR G1 33W 840 S 55D W	33	3 400	103	4000	≥85	55	18,6	1,135	White	Dia 228	99
DALI CONTROL												
93118390	LED DLR G1 23W 830 D 55D W	23	2 500	109	3000	≥85	55	18	0,705	White	Dia 172	90
ACCESSORIES												
93114811	DLR Lens 18W/23W 24D 10PC	-	-	-	-	-	24	n/a	0,0543	-	Dia 106	16
93114812	DLR Lens 18W/23W 36D 10PC	-	-	-	-	-	36	n/a	0,0543	-	Dia 106	16
93114813	DLR Lens 18W/23W 55D 10PC	-	-	-	-	-	55	n/a	0,0543	-	Dia 106	16
93114814	DLR Lens 33W 24D 10PC	-	-	-	-	-	24	n/a	0,0889	-	Dia 138	16
93114815	DLR Lens 33W 36D 10PC	-	-	-	-	-	36	n/a	0,0889	-	Dia 138	16
93114986	DLR Lens 33W 55D 10PC	-	-	-	-	-	55	n/a	0,0889	-	Dia 138	16
93114987	DLR Reflector 18W/23W specular	-	-	-	-	-	-	-	0,05	-	Dia 130	53
93114988	DLR Reflector 33W specular	-	-	-	-	-	-	-	0,084	-	Dia 186	60

Dimensions (mm)

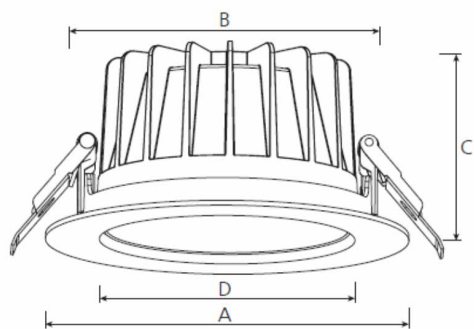

Description	A	B	C	D	Size (mm)	Weight (kg)
LED DLR G1 10Wxxx	95	80	54	63	Ø95x54	0.230
LED DLR G1 18Wxxx	172	145	90	127	Ø172x90	0.840
LED DLR G1 23Wxxx	172	145	90	127	Ø172x90	0.840
LED DLR G1 33Wxxx	228	195	99	176	Ø228x99	1.305

Ordering information

Internal Code	Generation	Wattage	CRI	CCT	Control	Beam angle	Finishing / Bezel color	Shipment
LED DLR	G1 - Generation 1	10W	8 - 80 CRI	30 - 3000K	S - Static	24D - 24 degree	W - White	DS - Direct Shipment
		18W		40 - 4000K		36D - 36 degree		
		23W	9 - 90 CRI	55D - 55 degree		B - Black		
		33W						

Example: LED DLR G1 18W 830 S 55D W - 18W 80 CRI 3000K IP54 COB downlight with 55° beam angle optic and static driver in white housing

Photometric data

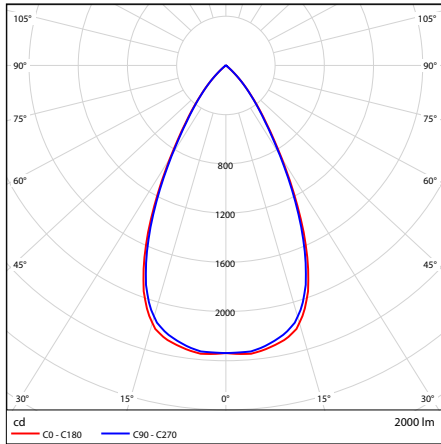

18W 3000K

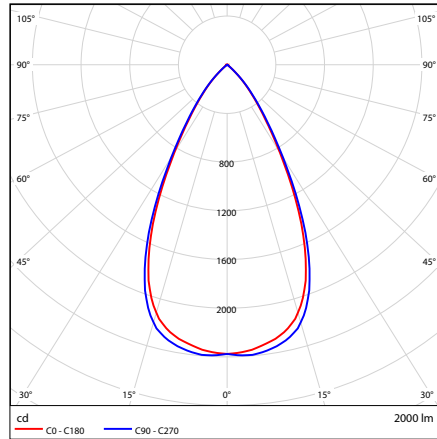

18W 4000K

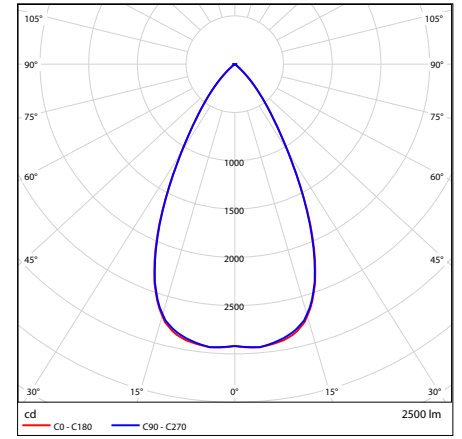

23W 3000K

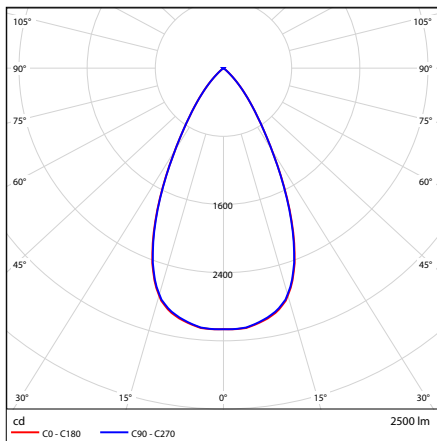

23W 4000K

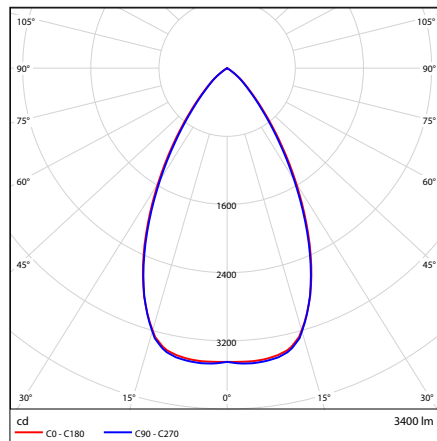

33W 3000K

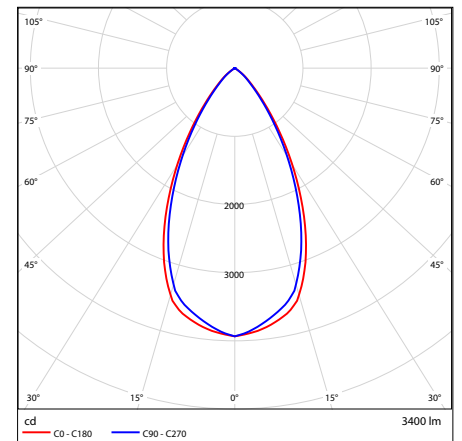

33W 4000K

Photometry is based on LM79

Regulatory and standards

Regulatory mark: CE

Regulations: 2014/35/EU, 2014/30/EU, 2011/65/EU, (framework 2009/125/EC) EU/1194/2012 amended by EU 2015/1428, (framework 2010/30/EC) 874/2012 and 518/2014*, 2012/19/EU*

Harmonised standards: EN 60598, EN 62493, EN 61547, EN55015, EN 61000, refer to CE Declaration of Conformity and Technical File for details

Photobiological risk assessment group 0. The product is considered safe, does not pose any photobiological hazard

*not on DOC