

Nobila



Product information

Introducing Tungsram's latest LED decorative fixture, the Nobila, which has the advantage of aesthetic outdoor luminaires with great performance. Designed to replace 35-100 W HID and 24-36 W CFL fixtures, the nobila is a great LED solution for roads, where heritage style is needed.

Application areas



Pedestrian street



Car park



Street & residential road lighting

Driver features

- Electronic, dimmable driver: Dali, CLO and dynadim from 20-90W
- Minimum dimming level 5,5 W

Structures and materials

- Housing material: die-cast aluminium body, corrosion resistant screws
- Color: RAL9005 or any RAL color
- Optic material: coated polycarbonate
- Optical cover: UV stabilized polycarbonate
- Gear Tray material: galvanized steel

Performance

- Rated luminous flux range: from from 2700 to 10600lm at 4000K
- Rated luminaire efficacy: Up to 135lm/W at 4000K
- Photometric code: 730/559, 740/559
- Rated median useful life and the associated rated LM factor: L80B50 > 100.000 hours
- Rated useful life and the associated rated LM factor: L90B10 > 62.000 hours
- Rated abrupt failure <10% (100.000 hours)
- Lumen maintenance code: 9
- Rated ambient temperature (tq) related to performance for a luminaire: 25°C

Definitions and tolerances according to IEC62722-2-1:2014

Installation and maintenance

Mounting options:

- Post top coupler \varnothing 48mm-76mm
- Recommended mounting height: 4-15m
- Weight: 6,5 kg
- Only two hand-tools required for installing the fixture
- Storage temperature up to 85°C.
- Ambient temperature from -40°C to +50°C (max. temperature is 35°C for 70W and 80W; 25°C for 90W versions)

Optics

Lens layout (4 lenses in every scenario):

- A: asymmetric
- S: symmetric
- C: circular

Available photometric distributions:

- C: optimized for high traffic ME class roads
- E: optimized for narrow S class roads
- F: optimized for wide S class roads

- AC - asymmetric C
- AE - asymmetric E
- AF - asymmetric F
- AH - asymmetric H
- SC - symmetric C
- SE - symmetric E
- SF - symmetric F
- CC - circular C
- CE - circular E
- CF - circular F

Rated colour rendering index: >70

Rated correlated colour temperatures: 3000K, 4000K

S/P rating for: 3000K - 1.33, 4000K - 1.56

ULOR: 0

Rated initial chromaticity co-ordinate values:

3000K - CIE(x=0.43, y=0.403) 5SDCM

4000K - CIE(x= 0.38, y= 0.38) 5SDCM

Electrical

Input voltage and frequency: 220-240V, 50-60Hz

Class I, Class II

Surge protection (driver immunity): 10kV

Rated input power: 21W to 94W

Standards and regulation

CE, Directive 2014/30/EU, 2014/35/EU, 2009/125/EC, 1194/2012/EU, 2011/65/EU, EN 60598, EN 62471, EN 55015, EN 61000, EN 62493, EN 61547.

Other options available

NEMA socket, Class II, precabing , Extra Surge Protection (10kV/5kA)

Dimension (mm)

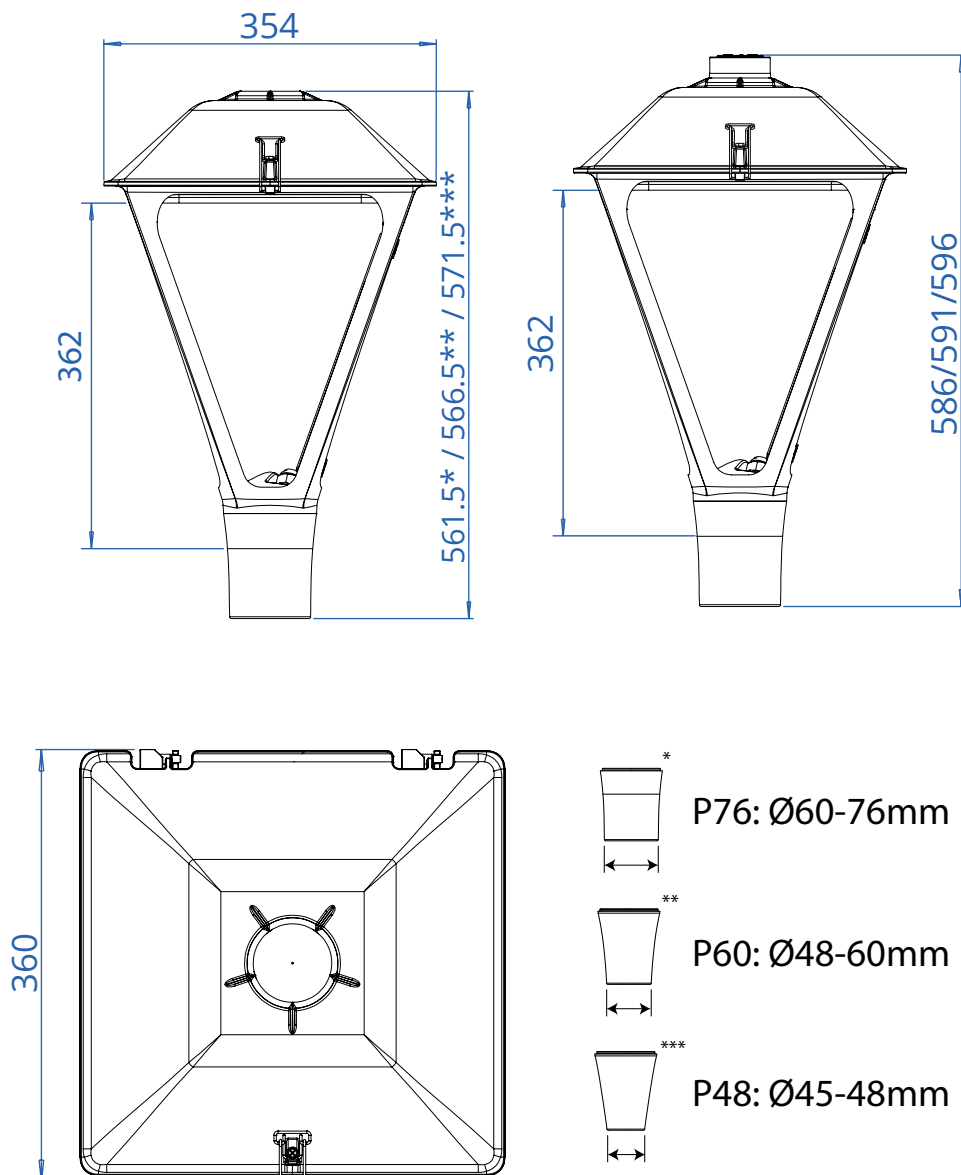

Typical photometrical features

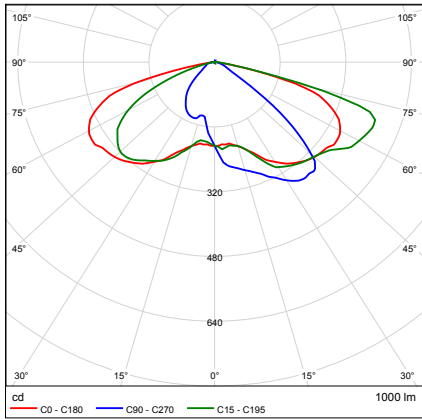

AC-asymmetric C

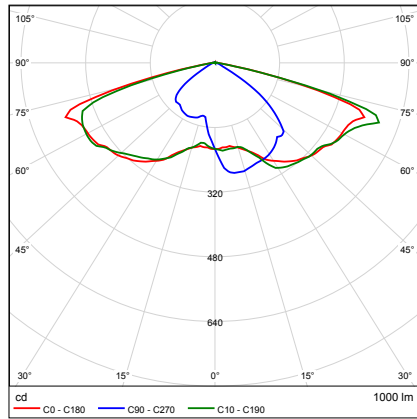

AE-asymmetric E

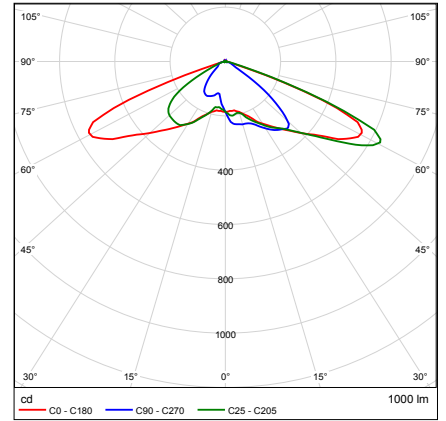

AF-asymmetric F

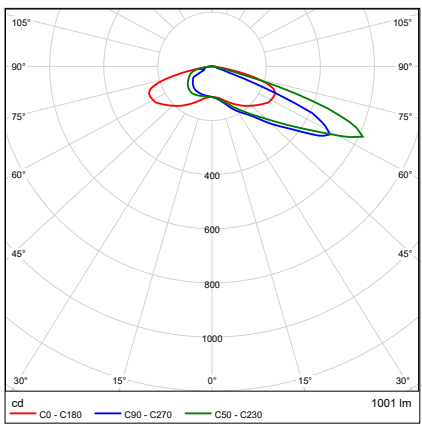

AH-symmetric H

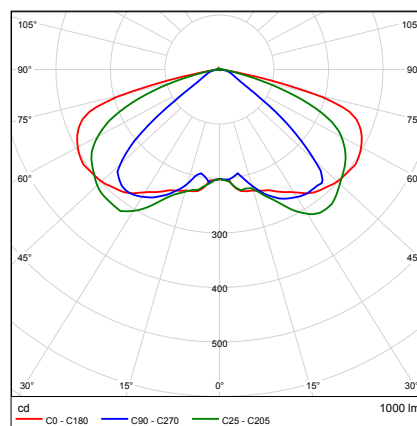

SC-symmetric C

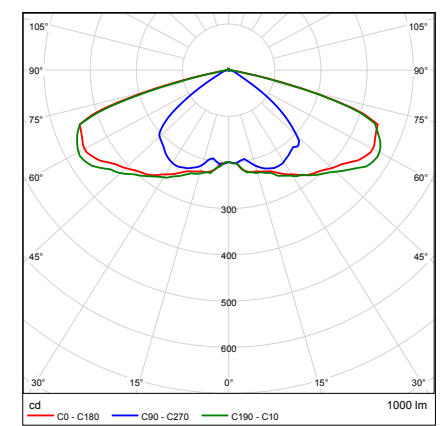

SE-symmetric E

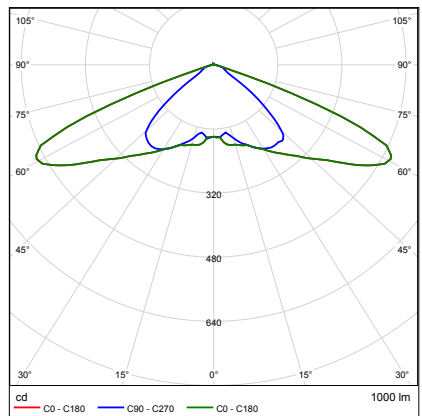

SF-symmetric F

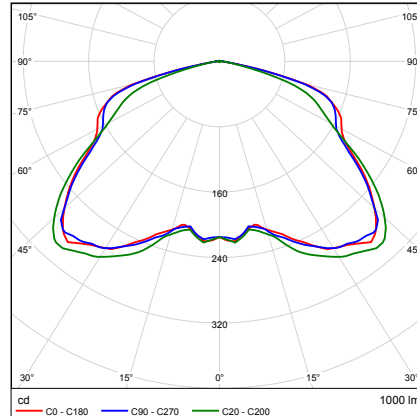

CC-circular C

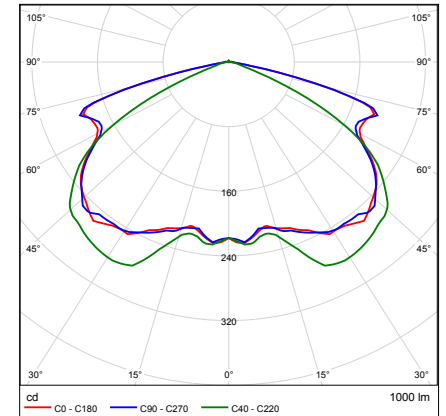

CE-circular E

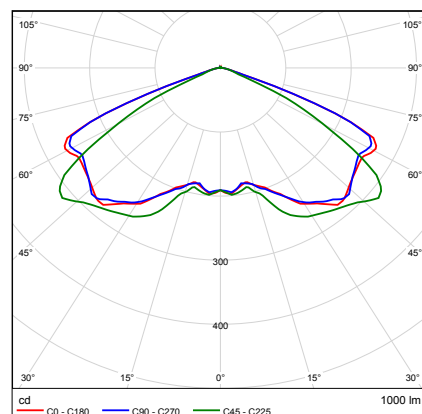

CF-circular F

Order logic

Name	Gen.	Optics	Power (W) *	CCT (K)	Control	Accessories	IEC Protection Classes	Precabling ***	Mounting	Color ****
NBL	1	CC	20	3 - 3000	N - No control	ST - Standard version	1 - Class I 2 - Class II	Px - Precabled with x meters	P48 - Ø45-48mm P60 - Ø48-60mm P76 - Ø60-76mm	R9005 Rxxxx
		CE	30		D - DALI	LS - 7-pin NEMA socket *****				
		CF	40		Yxx - DynaDIM **					
		AC	50	NLxx - No control + CLO **						
		AE	60		SP - Enhanced Surge Protection					
		AF	70							
		AH	80	DLxx - DALI + CLO **						
		SC	90	YLxx - DynaDIM + CLO **	LP - NEMA socket + SP *****					
		SE								
		SF								

Example: NBL/1/CC/40/3/N/ST/1/P1/P60

Exceptions:

- * Power consumption of luminaire can be programmed by the manufacturer in 1W steps withing the range (20-90)
- ** x can be up to 3 characters
- *** Min. 1 meter and max. 9 meters
- **** Other RAL colors available on request, for standard RAL9005 please leave it blank
- ***** NEMA socket (LS or LP) is not valid with Class II IEC protection