

Lucalox HO

High Pressure Sodium lamps
Tubular Clear
70W, 100W, 150W, 250W, 400W



Product information

From Tungshram's invention of HPS lighting in 1965 to today's advanced sources, Tungshram Lucalox High Pressure Sodium lamps have led the way in quality and innovation. Tungshram Lucalox HO lamps are highly efficient with acceptable colour rendering. High efficiency results in lower operating costs and thus a lower electricity bill. Lucalox HO lamps have an average rated life of 28,000 hours Long life means lower replacement and maintenance costs.

Applications areas



Specification summary

Lucalox XO Tubular Clear

Product Code	93102250	93102252	93102249	93102251	93102248
Product Description	LU70/90/HO/T/E27 TU MIC	LU100/100/HO/T/E40 TU MIC	LU150/100/HO/T/E40 TU MIC	LU250/100/HO/T/E40 TU MIC	LU400/HO/T/E40 TU MIC
Nominal Wattage [W]	70	100	150	250	400
Rated Wattage [W]	73	100	157	265	404
Weighted Energy Consumption [kWh/1000 hrs]	80.56	110.44	172.70	291.93	444.40
Volts [V]	90	100	100	100	100
Cap	E27	E40	E40	E40	E40
Nominal Lumen [lm]	6500	10400	17500	32500	56200
Rated Lumen [lm]	6613	10466	17600	33114	56200
Rated Lamp Efficacy [lm/W]	90	104	112	125	135
Energy Efficiency Class [EEC]	A+	A+	A+	A+	A++
Mercury Content [mg]	8	8	20	20	25
Average Rated Life [h]	28000	28000	28000	28000	28000
Nominal CCT [K]	2000	2000	2000	2000	2000
Colour Rendering Index [Ra]	21	21	21	21	21
Ambient Temperature [°C]	25	25	25	25	25
Bulb	Soft	Hard	Hard	Hard	Hard
Mass Weight [g]	75	120	120	140	170
Operating Position	Universal	Universal	Universal	Universal	Universal
Minimum Starting Temp. [°C]	-40	-40	-40	-40	-40

Dimensions

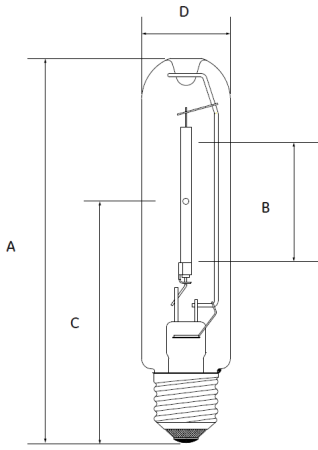

Lucalox HO Tubular Clear

Product Code	93102250	93102252	93102249	93102251	93102248
Wattage (W)	70	100	150	250	400
A Length [mm]	156	211	211	260	283
B Arc Gap [mm]	35	42	47	64	81
C LCL [mm]	102	132	132	158	175
D Diameter [mm]	39	48	48	48	48

Survival rate and lumen maintenance

Average lamp life & lumen maintenance is based on laboratory tests of a large number of representative lamps under controlled conditions, including operation at 11 hours per start on ballasts having specified electrical characteristics.

The following conditions can reduce average lamp life and lumen maintenance:

- Frequent on/off switching
- High line voltage
- Vibration
- High ambient temperature within the
- Ballast and ignitor characteristics

Average rated life

The survival of individual lamps or particular groups of lamps depends on these system conditions, and actual data may fall dependent upon the lamp operating conditions even below the lower limit (see Lamp survival graphs).

For cost-of-light calculations involving these lamps, the following estimated operating times are suggested for 50% survival:

Lumen maintenance

Under the same controlled conditions, initial reference lumens refer to the lamp lumen output after 100-hours burning. Due to variations in systems and service conditions (in particular the burning cycle), actual lamp performance can vary from the reference lumen ratings. The lumen maintenance (light output during life) of individual lamps or particular groups of lamps may fall dependent upon the lamp operating conditions even below the line (see lumen maintenance graphs).

Survival rate of HPS Lucalox™ HO lamps (70W)

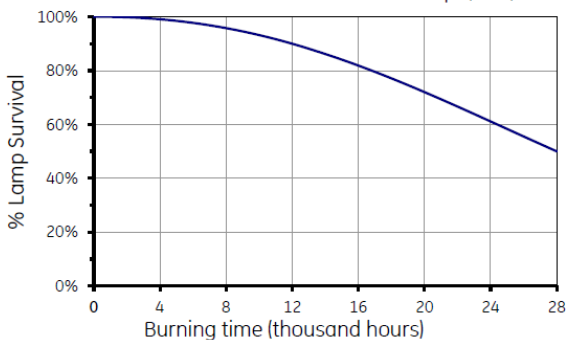

Lumen maintenance of HPS Lucalox™ HO lamps (70W)

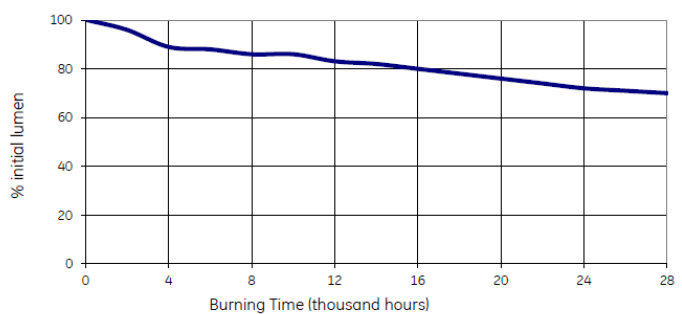

Survival rate of HPS Lucalox™ HO lamps (100 -400W)

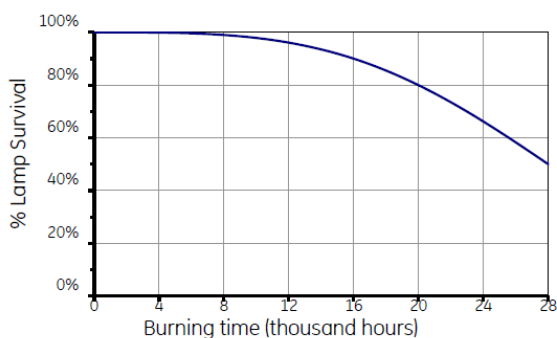

Lumen maintenance of HPS Lucalox™ HO lamps (100 -400W)

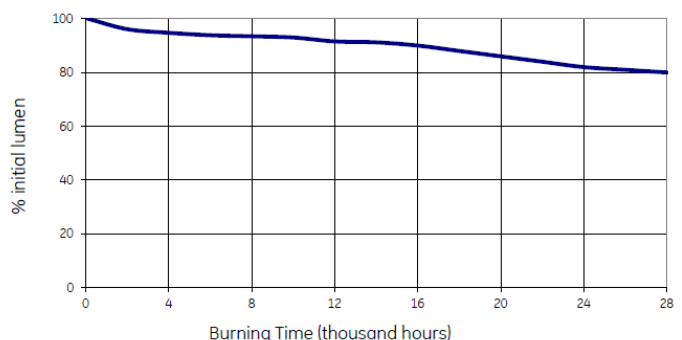

Electrical data

Data is based on a nominal lamp operating from a nominal choke (reactor) ballast with power factor correction. Supply power is based on a typical commercially available ballast.

Wattage	Volts ±15 [V]	Nominal Current [A]	Nominal Power [W]	Current Crest Factor
70	90	0.98	70	1.45
100	100	1.2	100	1.45
150	100	1.8	150	1.45
250	100	3.0	250	1.45
400	100	4.6	400	1.45

Circuit data (typical data of lamps with nominal voltage)

Wattage	Supply Current (A)		Supply Power (W)		Power Factor Lagging		Percentage 3rd Harmonic	PFC Capacitor [µF]	During Run-up (A)		Failed/ Hot Lamp (A)	
	230V	240V	230V	240V	230V	240V			230V	240V	230V	240V
Supply All Types												
70	0.40	0.40	83	86	0.90	0.90	14	10	0.45	0.42	0.72	0.75
100	0.54	0.52	113	114	0.91	0.91	15	12	0.64	0.60	0.87	0.90
150	0.83	0.80	171	172	0.90	0.90	15	20	0.91	0.84	1.45	1.50
250	1.35	1.30	275	276	0.89	0.89	15	30	1.58	1.48	2.17	2.30
400	2.20	2.10	426	427	0.84	0.85	12	40	2.80	2.60	2.79	3.00

Electrical data

Wattage	100 Hours Lumens	CCT [K]	CRI [Ra]	DIN5035 Class.
70 (HO)	6500	2000	21	4
100 (HO)	10400	2000	21	4
150 (HO)	17500	2000	21	4
250 (HO)	32500	2000	21	4
400 (HO)	56200	2000	21	4

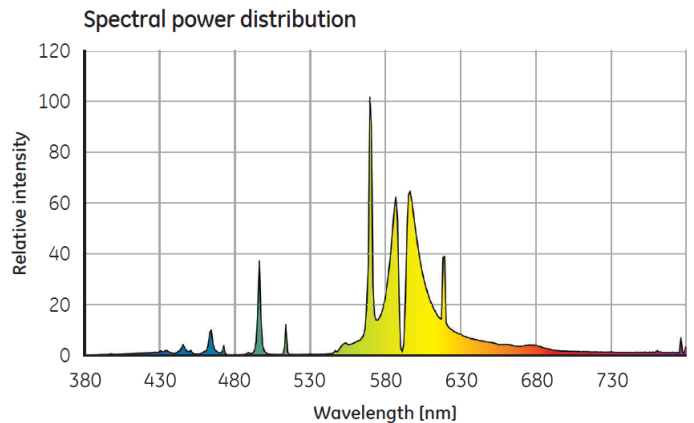

Run-up characteristics

The graph shows typical run-up characteristics for a 250W Lucalox™ lamp. Time for the light output to reach 90% of the final value is determined by supply voltage and ballast design. Typical values are:

Wattage	70	100	150	250	400
Run-Up (Mins)	<4	4	4	5	3

Run-up characteristics

All ratings re-strike within 1 about minute following a short interruption in the supply. Actual re-strike time is determined by ignitor type, pulse voltage and cooling rate of the lamp.

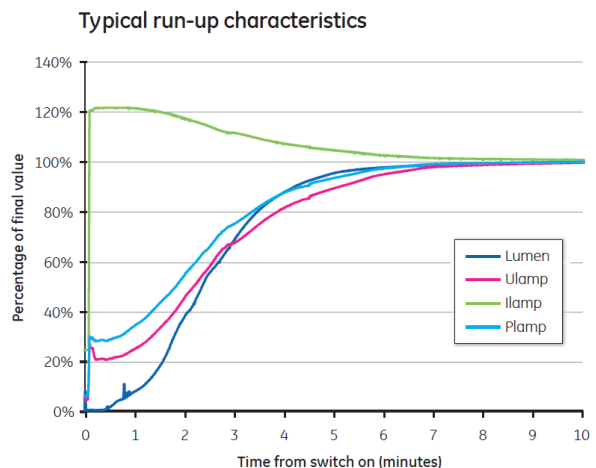

Supply voltage

Lamps are suitable for supplies in the range 220V to 250V 50/60Hz for appropriately rated series choke (reactor) ballasts. Supplies outside this range require a transformer (conventional, high reactance or CWA) to ensure correct lamp operation. Lamps start and operate at 10% below the rated supply voltage when the correct control gear is used. However, in order to maximize lamp survival, lumen maintenance and colour uniformity the supply voltage and ballast design voltage should be within $\pm 3\%$. Supply variations of $\pm 5\%$ are permissible for short periods only. This may be achieved by measuring mean supply voltage at the installation and selecting ballasts with appropriate settings.

Effect of supply voltage variations on performance

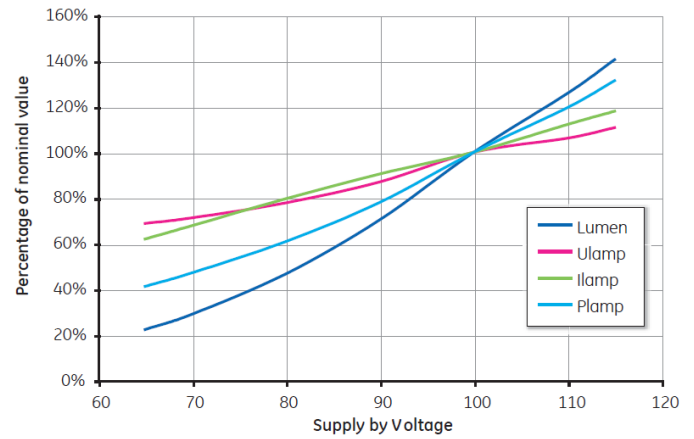

Control gear

It is essential to use a ballast appropriate to the supply voltage at the luminaire. Typical wiring diagrams for control circuits incorporating "superimposed" or "impulser" ignitor and choke (reactor) ballasts are shown. Refer to actual choke and ignitor manufacturers data for terminal identification and wiring information.

Typical impulser ignitor circuit

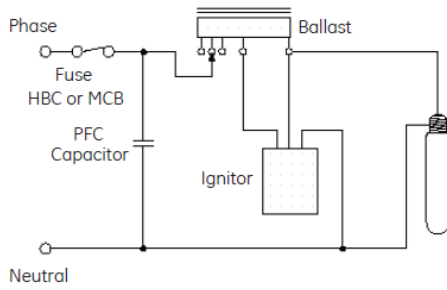

Typical superimposed ignitor circuit

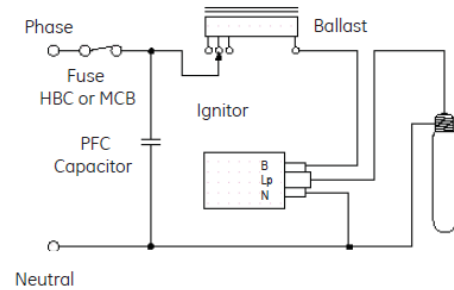

Lamp operating temperature limits

	70W	100-400W
Maximum cap temperature	210°C	250°C
Maximum bulb temperature	310°C	400°C

Luminaire voltage rise

To maximise lamp life it is essential that luminaires are designed so that when lamps are enclosed lamp voltage rise does not exceed the following values:

Wattage	70	100	150	250	400
Luminaire voltage rise (tubular)	5	7	7	10	12

Ballasts

Lamps are fully compatible with ballasts manufactured for high pressure sodium lamps to IEC 60662. Ballasts should comply with specifications IEC 60922 and IEC 60923.

Ballast Thermal Protection — Use of ballasts incorporating thermal cut-out is not a specific requirement but is a good optional safety measure for installation.

Ballast Voltage Adjustment — Series choke (reactor) ballasts incorporating additional tapplings at $\pm 10V$ of the rated supply voltage are recommended. Alternatively a single additional tapping 10V above the rated supply voltage will ensure lamps are not overloaded due to excessive supply voltage.

Ignitors

Both Superimposed and Impulser type ignitors are suitable. It is recommended that only Tungfram approved ignitors are used. Ignitors should comply with specifications IEC 60926 and IEC 60927 and have starting pulse characteristics as follows.

Watts	Min. PulseVoltage[kV] ¹	Max. PulseVoltage[kV] ²	Min. PulseWidth[μs] ³	Min. PulseRepetitionRate ⁴	Min. PulseRepetitionRate ⁴
70	1.8	2.3	1.95	1½ cycle	0.2
100	2.8	4.5	1.95	1 cycle	0.2
150	2.8	4.5	1.95	1 cycle	0.2
250	2.8	4.5	0.95	1 cycle	0.2
400	2.8	4.5	0.95	1 cycle	0.2

(1) When Loaded with 100 pF.

(2) When loaded with 20pF.

(3) At 90% peak voltage.

(4) From ignitor into lamp during starting.

Pulse Phase Angle: 60-90° el and/or 240-270° el.

During the production process, Tungfram Lucalox lamps are start tested according to the requirements of the IEC 60662 Standards and will therefore be compatible with ignitors designed for lamps to this standard and which comply with the relevant ignitor Standards (IEC 60926 & 60927). Examples of commercial ignitor manufacturers are:

BAG Turgi	MZN 70S (50/70W), MZN150S, MZN150SE-C (100/150W), MZN250SE (100/150/250W),	MZN400S(R) (100/150/250/400W) MZN400SU (100/150/250/400W) MZN1000S (1000W)
ERC	ERC 640006 (100-400W)	
May & Christe	May & Christe ZG1.0SE (50/70W) ZG2.0SE (100/150W) ZG4.5SE (100/150/250/400W)	
Parry	Parry PB070#, PBE070, PXE070 (50/70W) PBO19#, PTH150# (150W) PB404# (250W/400W)	PAE400, PXE400, PWE400(150/250/400W)
Thorn	G53503#, G53353.4#, G53353.2#, G53434 (50/70W) G53504#, G53511, G53476, G53455,	G53250 (100/150/250/400W) G53282/B# (150/250/400W) G53316 (100/150/250/400W)
Tridonic	ZRM2-ES, ZRM2-IS (50/70W) ZRM1.8ES/2 (100/150W) ZRM6-ES (100/150/250/400W)	ZRM12-ES (100/150/250/400W)

Impulser type - approved only when used with a suitable ballast.

Cable between ignitor and lamp – The cable connected between the lamp and a superimposed ignitor “Lp” terminal, or the ballast when using an impulser ignitor, must be rated at a minimum 50/60Hz voltage of 1000V. Mineral-insulated cables are not suitable for connecting the lamp to the control gear. To achieve good starting superimposed ignitors must be adjacent to the luminaire. Cable capacitance of wiring between the ignitor “Lp” terminal and the lamp should not exceed 100pF (<1 metre length) when measured to adjacent earthed metal and/or other cables, unless otherwise stated by the ignitor manufacturer. When using impulser type ignitors longer cable lengths between ballast and lamp are normally permissible. Limits for particular ignitors are available on request from Tungfram Lighting or directly from the ignitor manufacturer.

Timed ignitors

Use of a “timed” or “cut-out” ignitor is not a specific requirement, but it is a good optional safety feature for installation. The timed period must be adequate to allow lamps to cool and restart when the supply is interrupted briefly (see “Hot re-strike time”).

PFC capacitors for choke (reactor) circuits

Power Factor Correction is advisable in order to minimise supply current and electricity costs. For 220-250V supplies 250V±10% rated capacitors are recommended as follows:

Wattage	70	100	150	250	400	1000
PFC Capacitor	10µF	12µF	20µF	30µF	40µF	85µF

Safety warnings

The use of these products requires awareness of the following safety issues: Read safety notice enclosed with the lamp.

