

# LED Downlight IP54 UGR<19



Preliminary  
DATA SHEET



## Product information

The new Tungsram IP54 Downlight range with traditional deep reflector (UGR<19) provides the perfect combination of high-efficiency, comfortable lighting and design, without compromising on light performance (colour rendering and colour uniformity). Due to the interchangeable optics (24°, 36°, 55° beam angle) it offers a wide choice of options for creating the desired ambience. IP54 range is designed for general lighting applications in offices, supermarkets, shops, schools, hotels, etc. It is also widely used for public areas, such as stairways, lobbies, receptions.

## Benefits

- High luminous efficiency
- High energy savings up to 70% when compared with conventional CFL fixtures
- Easy installation and maintenance
- Affordable solution for retrofit or new installations

## Fixture structure

- Die-cast aluminium housing or good heat dissipation and replaceable polycarbonate lenses
- Tested for glow wire at 650°C

## Features

- 24°, 36°, 55° beam angle replaceable optic, specular reflector
- Low glare rate, UGR<19
- IP54 protection rating
- Lifetime >70k hours at 25°C (L70/B50)
- 3000K & 4000K CCT
- PF >0.9
- 80 CRI+ (90 CRI optional)
- Ambient temperature: -20°C~45°C
- Citizen LED chip
- Class II
- IK06 rating
- Aluminium die-cast housing with PC bezel and PC lenses
- Remote static driver (DALI optional) – compatible with TU Emergency Converter Kit

## Application areas



General lighting /  
Office



Shop / Supermarket /  
Hotel / Hospitality

## Specification summary

Product code	Product code (DS)	Description	Lumen (lm)	Wattage (W)	Efficacy (lm/W)	CCT (K)	Control	CRI
93113196	TBD	LED DLR G1 18W 830 S 55D W	2000	18	111	3000K	Static	>80
93113197	TBD	LED DLR G1 18W 840 S 55D W	2000	18	111	4000K	Static	>80
93113198	TBD	LED DLR G1 23W 830 S 55D W	2500	23	109	3000K	Static	>80
93113199	TBD	LED DLR G1 23W 840 S 55D W	2500	23	109	4000K	Static	>80
93113200	TBD	LED DLR G1 33W 830 S 55D W	3400	33	103	3000K	Static	>80
93113201	TBD	LED DLR G1 33W 840 S 55D W	3400	33	103	4000K	Static	>80

### Adjustable accessories\*

93114811	TBD	DLR Lens 18W/23W 24D 10PC
93114812	TBD	DLR Lens 18W/23W 36D 10PC
93114813	TBD	DLR Lens 18W/23W 55D 10PC
93114814	TBD	DLR Lens 33W 24D 10PC
93114815	TBD	DLR Lens 33W 36D 10PC
93114986	TBD	DLR Lens 33W 55D 10PC
93114987	TBD	DLR Reflector 18W/23W specular
93114988	TBD	DLR Reflector 33W specular

\*accessories to be ordered separately

## Dimensions (mm)

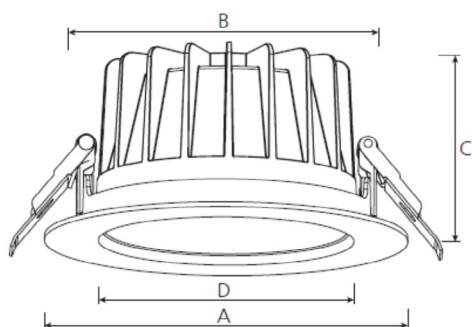

Description	A	B	C	D	Size (mm)	Weight (kg)
LED DLR G1 18Wxxx	172	145	90	127	Ø172x90	0.840
LED DLR G1 23Wxxx	172	145	90	127	Ø172x90	0.840
LED DLR G1 33Wxxx	228	195	99	176	Ø228x99	1.305



## Ordering information

Internal Code	Generation	Wattage	CRI	CCT	Control	Beam angle	Finishing / Bezel color	Shipment
LED DLR	<b>G1</b> - Generation 1	<b>18W</b> <b>23W</b> <b>33W</b>	<b>8</b> - 80 CRI <b>9</b> - 90 CRI	<b>30</b> - 3000K <b>40</b> - 4000K	<b>S</b> - Static	<b>24D</b> - 24 degree <b>36D</b> - 36 degree <b>55D</b> - 55 degree	<b>W</b> - White <b>B</b> - Black	<b>DS</b> - Direct Shipment

**Example:** LED DLR G1 18W 830 S 55D W - 18W 80 CRI 3000K IP54 COB downlight with 55° beam angle optic and static driver in white housing

# Photometric data

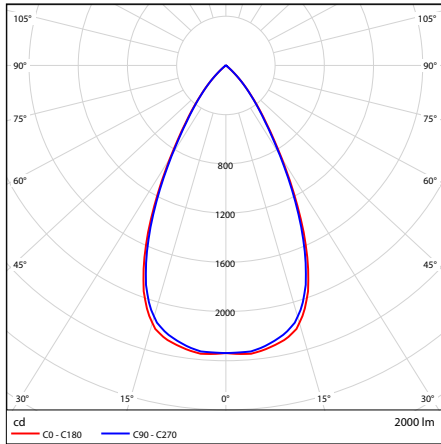

18W 3000K

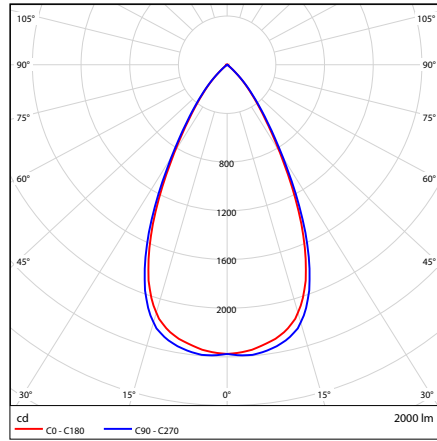

18W 4000K

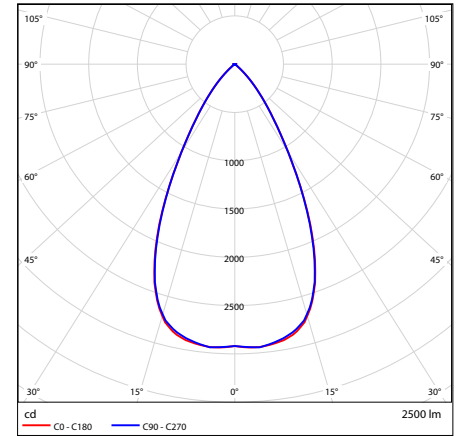

23W 3000K

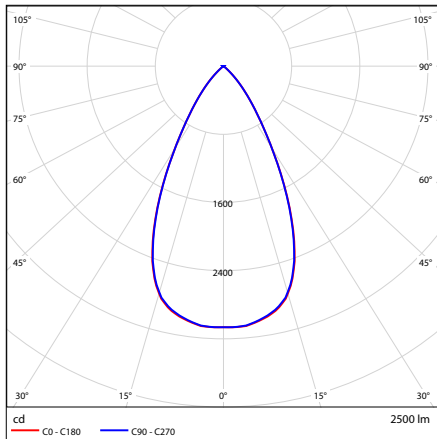

23W 4000K

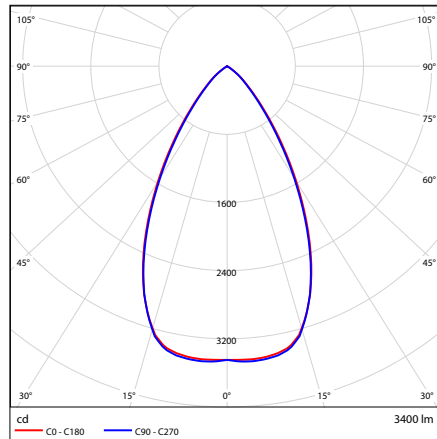

33W 3000K

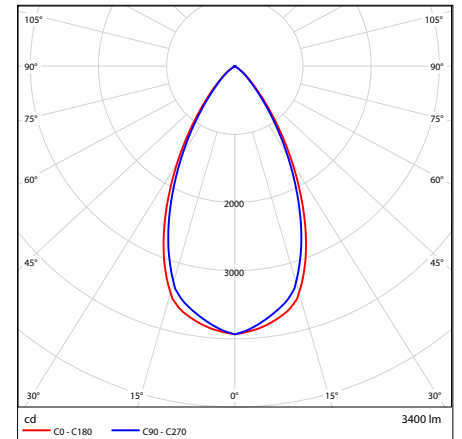

33W 4000K

Photometry is based on LM79

## Regulatory and standards

**Regulatory mark:** CE

**Regulations:** 2014/35/EU, 2014/30/EU, 2011/65/EU, (framework 2009/125/EC) EU/1194/2012 amended by EU 2015/1428, (framework 2010/30/EC) 874/2012 and 518/2014\*, 2012/19/EU\*

**Harmonised standards:** EN 60598, EN 62493, EN 61547, EN55015, EN 61000, refer to CE Declaration of Conformity and Technical File for details

Photobiological risk assessment group 0. The product is considered safe, does not pose any photobiological hazard

\*not on DOC