

High Bay IP20

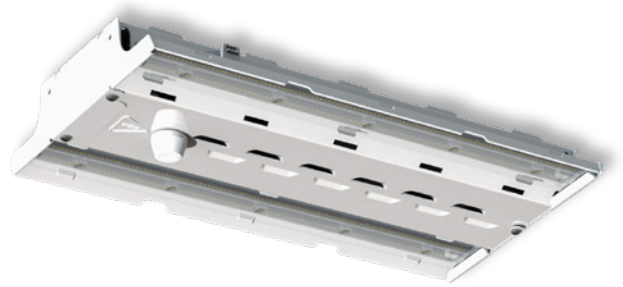

DATASHEET

Product information

The new Tungsram High Bay LED luminaire is an exceptional mixture of value and performance. The product range has been upgraded to reach very high efficacy up to 177 lm/w and cover lumen packages between 10,000 – 30,000 lumens. The range includes DALI and various sensor versions, such as the Nedap Luxon IoT Node, to enable internet connection and wireless control of the luminaire range. With the improved efficacy, wide range of control options and higher lumen output, the HB IP20 is an ideal choice to replace high watt HID and T5/T8 LFL fixtures in high bay and low bay applications, in industrial and commercial buildings.

Applications

- Designed to meet recommended luminance and illuminance requirements for High bay and Low bay applications

Housing

- Combination of steel and aluminium housing
- HB IP20 Series' design accommodates 1 or 2 modules with 2 LED units per module
- IP40 rating for the optical LED compartment, IP20 rating for the electrical part

Finish

- Painted white finish

Controls

Available with various driver and sensor options

- Fixed output for Standard (S) series only
- DALI with High (H) and with standard (S) series.
- Motion & lux sensor – enables standalone fixture control up to 15m installation height. Can be used with Standard (S) series only.
- RF wireless sensor – enables control for groups of fixtures with RF (Radio Frequency) sensor in a local lighting control system grid without additional DALI wires, up to 15m installation height. Can be used with High (H) and Standard (S) series as well.

Remote controller accessories

Need to be ordered separately:

- Remote controller - 93110511

Mounting

- Various mounting options: Cable or threaded rod kit. Mounting accessories need to be ordered separately.

Ratings

- Temperature Rated at -30°C to +60°C
- L80B50 50 000hrs - 100 000 hrs @ 50C
- L80B50 80 000hrs - 100 000 hrs @ 25C

Electrical

- 220-240V/50-60Hz
- System power factor is >90% and THD <20%

LED & Optical Assembly

- TU HB Series optical system enable LEDs to provide optimised illumination for open floor and racked aisles with photometric distributions of 30, 60 and 90 degrees achieved with Lenses (L). Optics are designed for commercial & industrial applications where mounting height, fixture spacing & light levels help determine optical selection.
- A high performance product utilising top performing LED chips, offering exceptional reliability.
- 4000K & 5000K versions with 70 & 80 CRI.

Order Logic

Product ID	Module / Efficiency / Lumen	CCT / CRI	Optic	Control	Options1
TU High bay IP20 - High efficiency					
TU HB IP20 G1	1H10 - 1M High 10klm 1H15 - 1M High 15klm 1H20 - 1M High 20klm 1H25 - 1M High 25klm 2H30 - 2M High 30klm	4K-4000K 70 CRI70 5K-5000K 70 CRI70 4K-4000K 80 CRI80 5K-5000K 80 CRI80	C1-120° Clear D1-120° Diffuse L9-90° Clear L6-60° Clear L3-30° Clear	DL-DALI RF-RF sensor (Motion and Lux)	ST-Standard EA-EM auto-test
TU High bay IP20 - Standard Efficiency					
TU HB IP20 G1	1S10 - 1M Std 10klm 1S12 - 1M Std 12 klm 1S20 - 1M Std 20klm 1S22 - 1M Std 22 klm 1S30 - 1M Std 30klm	4K-4000K 70 CRI70 5K-5000K 70 CRI70 4K-4000K 80 CRI80 5K-5000K 80 CRI80	C1-120° Clear D1-120° Diffuse L9-90° Clear L6-60° Clear L3-30° Clear	FX-Fix output DL-DALI SN-Sensor (On/OFF) RF-RF sensor (Motion and Lux)	ST-Standard EA-EM auto-test

Module / Efficiency / Lumen	5000K 70CRI Clear 120° Optics DALI Driver				CCT/CRI multipliers		Optical multipliers	
	Module	Power(W)*	Lumen	lm/W				
1H10	1	56	9900	177	5K70	100%	C1	100%
1H15	1	86	15000	174	5K80	96%	D1	96%
1H20	1	116	19500	168	4K70	96%	L9	100%
1H25	1	148	25000	167	4K80	95%	L6	101%
2H30	2	170	29200	172			L3	103%
1S10	1	67	9670	144				
1S12	1	85	12000	141				
1S20	1	141	19900	141				
1S22	1	157	22000	140				
1S30	1	199	29200	147				

Our products are in compliance with IEC 60598-2-1:1979+A1:1987 used in conjunction with IEC 60598-1:2014.

* Fix output and sensor versions could have slightly different values

Photometric data

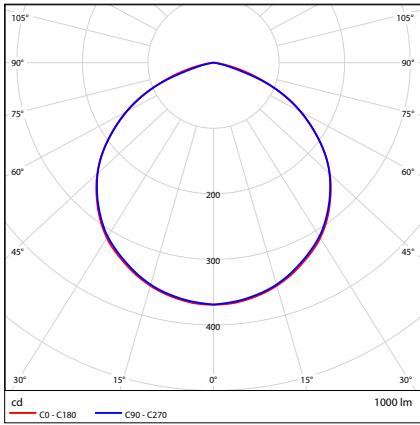

C1

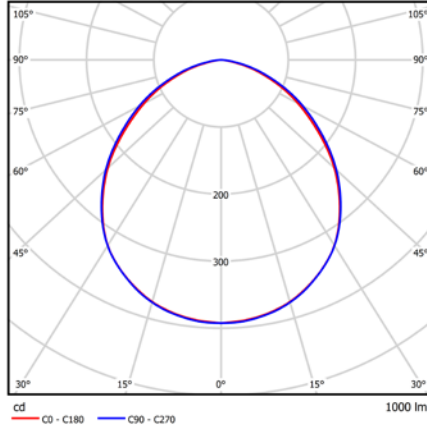

D1

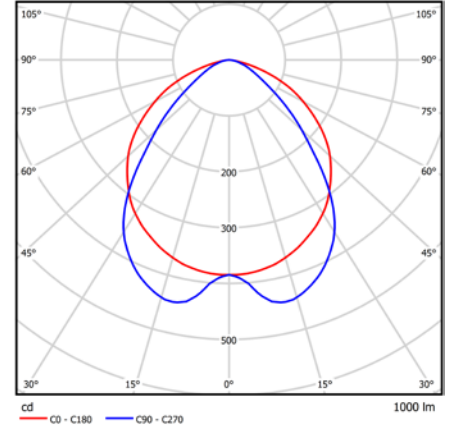

L9

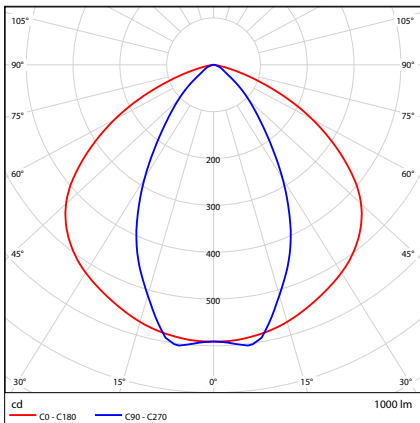

L6

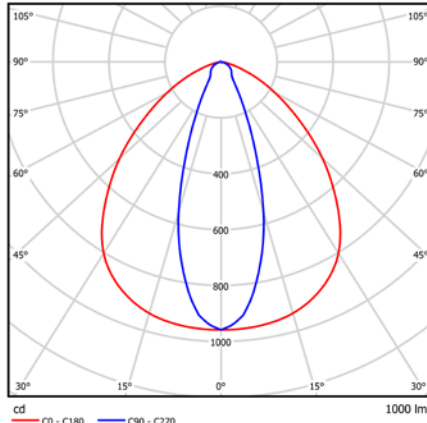

L3

Mounting & Accessories

Mounting Options

Image

Accessories

Rod Mount (optional)

Available on all fixture configurations. Attaches to M10 threaded rod (rod and nuts not included).

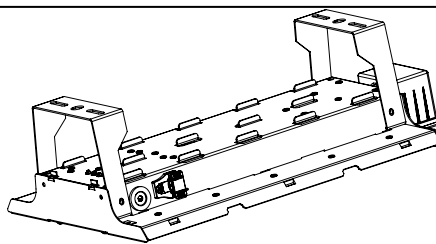

THB IP20 Bracket kit **93108564***
*2pcs/KIT

Y-Cable w/hook (optional)

Use with Standard Mounting Option only. Order separately. Sold per pair - suitable for one fixture 1.5 m, 3 m, 4.5 m, 6 m lengths available.

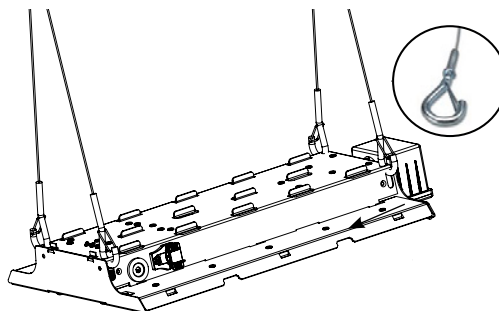

93091603
1.5m cable - 93091603
YCABLEHOOK05FTPAIR - 5 FOOT PAIR 5 FT

93091604
3 m cable
YCABLEHOOK10FTPAIR - 10 FOOT PAIR

93091605
4.5 m cable
YCABLEHOOK15FTPAIR - 15 FOOT PAIR

93091686
6 m cable
YCABLEHOOK20FTPAIR - 20 FT PAIR 20FT

Tilted bracket kit

Available on all fixture configurations. Kit needs to be ordered separately.

93104725

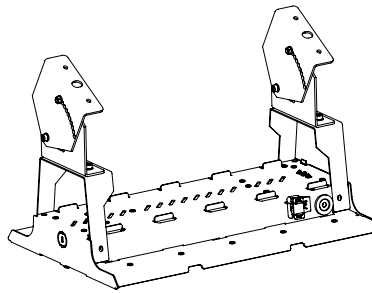

Dimensions (mm)

