

LED Start MR16

5W and 7W LED equivalents
for 35W and 50W
Halogen products



DATA SHEET

Product information

This new design in the MR16 range, offers a fantastic energy saving replacement option for the 35W and 50W Halogen solution. It is available in three colour temperatures with a smooth heat sink and flat front face.

Features & Benefits

- 35W and 50W equivalent
- Total Lumens: up to 670
- 15 000 hours solution (L70/B50)
- Three colour temperatures: 2700K, 3000K, 4000K
- A+ Energy Class
- Beam angle: 35°
- Warranty: 2 years with maximum 8000 burning hours according to GE Lighting Standard Warranty conditions

Application areas



Home



Hospitality



Retail

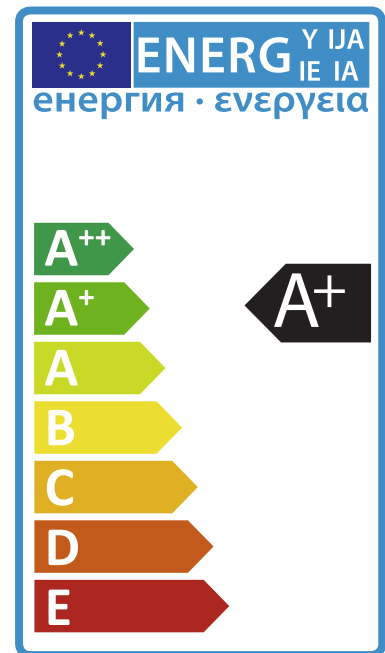

IEC Standards

- EN 55015: 2013+A1:2015: Limits and methods of measurement of radio disturbance characteristics of electrical lighting
- EN 61547: 2009: Equipment for general lighting purposed EMC immunity requirements
- EN 61000-3-2: 2014: Electromagnetic compatibility (EMC) –Part 3-2: Limits –Limits for harmonic current emissions (equipment input current up to and including 16A per phase)
- EN 61000-3-3: 2013: Electromagnetic compatibility (EMC) –Part 3-3: Limits –Limitation of voltage fluctuations and flicker in low-voltage supply systems for equipment with rated current up to 16A

Specification summary

Product Code	Direct Shipment Product Code	Product Description	Nominal/ Rated Power (W)	Repl Watt (W)	Nominal/ Rated Lumens (lm)	Nominal/ Rated Useful Lumens (lm)	Rated Peak Intensity (cd)	CCT (K)	WEC (kwh/1000h)	Pack Qty
93095381	93095382	LED Start MR16 5W(35) 827 35°	5,0	35	380	350	700	2700	5,0	1/8
93095383	93095384	LED Start MR16 5W(35) 830 35°	5,0	35	380	350	700	3000	5,0	1/8
93095385	93095386	LED Start MR16 5W(35) 840 35°	5,0	35	400	360	750	4000	5,0	1/8
93094461	93094462	LED Start MR16 7W(50) 827 35°	7,0	50	650	621	1200	2700	7	1/8
93094463	93094464	LED Start MR16 7W(50) 830 35°	7,0	50	650	621	1200	3000	7	1/8
93094465	93094466	LED Start MR16 7W(50) 840 35°	7,0	50	670	630	1300	4000	7	1/8

Common attributes

- Nominal/ Rated Life (L70/B50 hours): 25 000 Hrs
- Cap/Base: GU5.3
- Nominal/Rated Beam Angle : 35°
- Input Voltage 12V
- Colour Rendering Index >80
- Start-up/Warm-up time: <500 ms
- Switching Cycles: 30 000
- Power factor: 0.7 for 35Weq and 0.9 for 50Weq
- Lumen Maintenance Factor: 0.7
- Colour consistency: <6 SDCM
- A+ Energy Efficiency
- Non-dimmable

Recommended operation temperature

- Ths Max 96°C



Dimensions (mm)

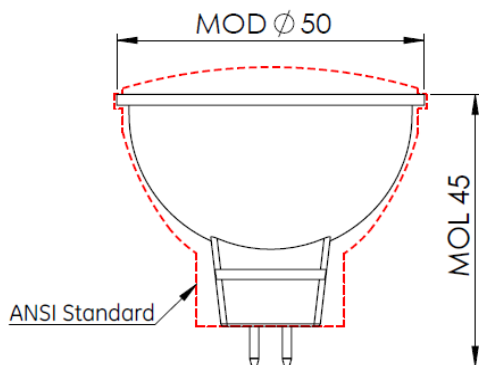

Packaging image



Operation and maintenance

- Store and use the lamps the same way as traditional lamps.
- Check your fixtures are properly wired and don't deliver voltage spike to lamps causing overheating/failure.
- Ambient temperature range -20° C to 40°C
- Lamps should be kept free from contamination.
- Good condition of the lamp-holder contacts is important to ensure proper operation of lamp.
- Ensure lamp is cool before removing.
- Switch off mains supply before installing/removing lamps.
- Not for use in totally enclosed recessed fixtures.
- These GE LED Start MR16 35&50W equivalent products are non-dimmable.

Spectral distributions

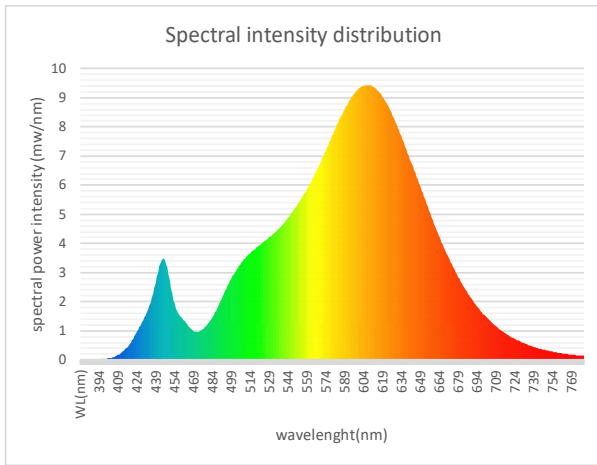

5W - 2700K

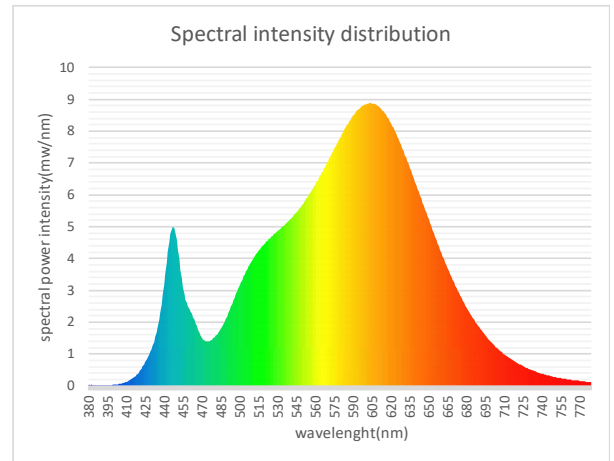

5W - 3000K

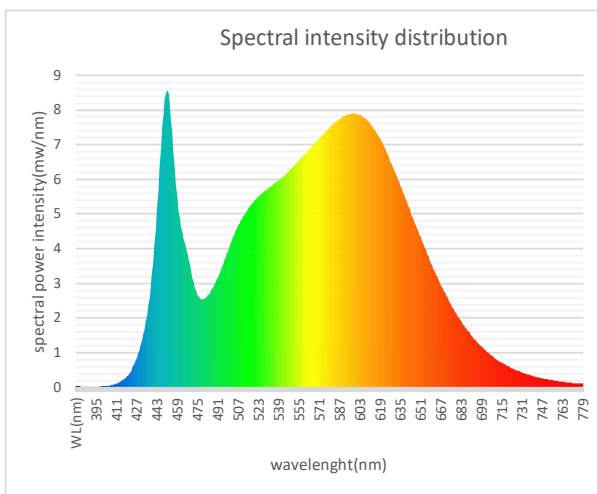

5W - 4000K

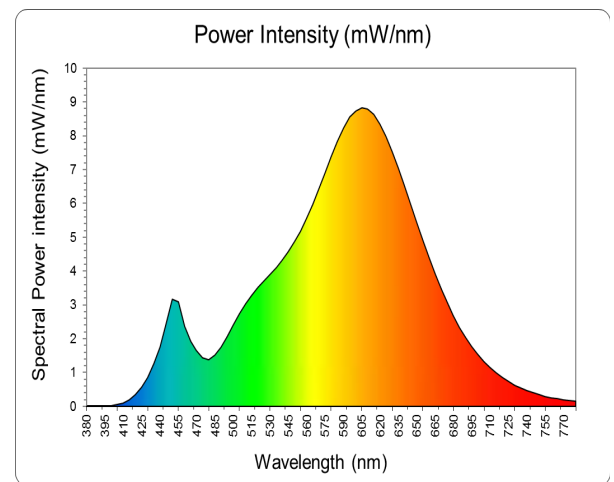

7W - 2700K

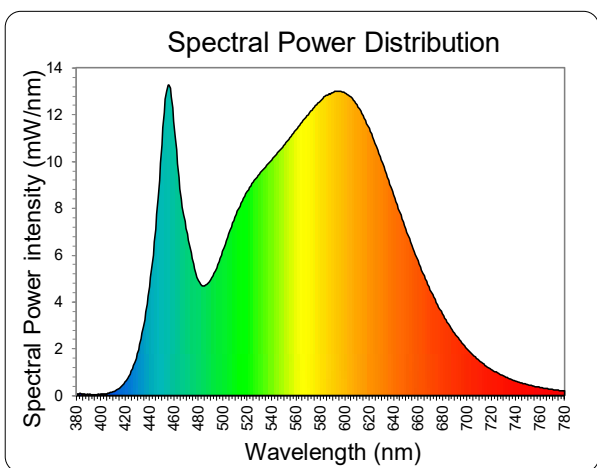

7W - 3000K

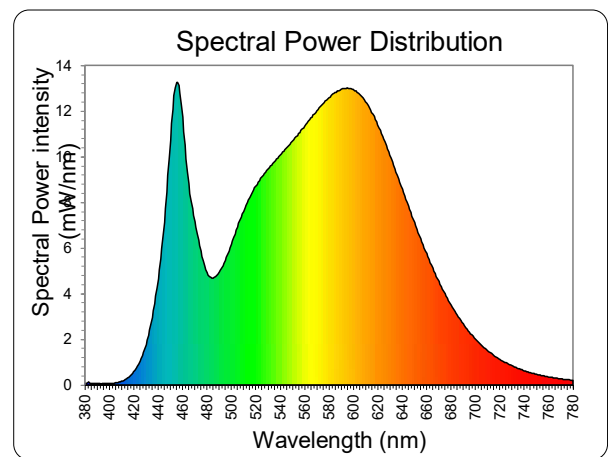

7W - 4000K

All values 180-400nm are 0